

## N-Channel 60-V (D-S) MOSFET

PRODUCT SUMMARY		
$V_{DS}$ (V)	$R_{DS(on)}$ ( $\Omega$ )	$I_D$ (mA)
60	2.5 at $V_{GS} = 10$ V	200

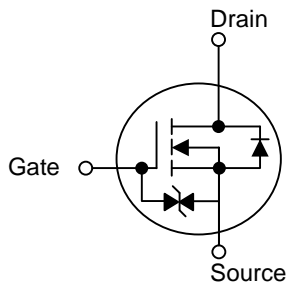
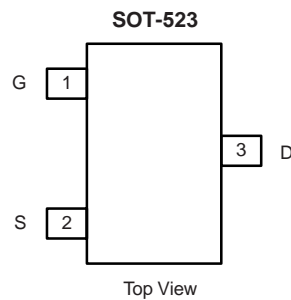

### FEATURES

- Low On-Resistance: 2.5  $\Omega$
- Low Threshold: 2 V (typ.)
- Low Input Capacitance: 25 pF
- Fast Switching Speed: 25 ns
- Low Input and Output Leakage
- DT-Trench Power MOSFET
- 1200V ESD Protection



### BENEFITS

- Low Offset Voltage
- Low-Voltage Operation
- Easily Driven Without Buffer
- High-Speed Circuits
- Low Error Voltage

### APPLICATIONS

- Direct Logic-Level Interface: TTL/CMOS
- Drivers: Relays, Solenoids, Lamps, Hammers, Display, Memories, Transistors, etc.
- Battery Operated Systems
- Solid-State Relays

ABSOLUTE MAXIMUM RATINGS $T_A = 25$ °C, unless otherwise noted			
Parameter	Symbol	Limit	Unit
Drain-Source Voltage	$V_{DS}$	60	V
Gate-Source Voltage	$V_{GS}$	$\pm 20$	
Continuous Drain Current ( $T_J = 150$ °C) <sup>b</sup>	$I_D$	$T_A = 25$ °C	200
		$T_A = 100$ °C	150
Pulsed Drain Current <sup>a</sup>	$I_{DM}$	700	mA
Power Dissipation <sup>b</sup>	$P_D$	$T_A = 25$ °C	0.15
		$T_A = 100$ °C	0.07
Maximum Junction-to-Ambient <sup>b</sup>	$R_{thJA}$	390	°C/W
Operating Junction and Storage Temperature Range	$T_J, T_{stg}$	- 55 to 150	°C

Notes:

- Pulse width limited by maximum junction temperature.
- Surface Mounted on FR4 board.

<b>SPECIFICATIONS</b> $T_A = 25\text{ }^\circ\text{C}$ , unless otherwise noted						
Parameter	Symbol	Test Conditions	Limits			Unit
			Min.	Typ. <sup>a</sup>	Max.	
<b>Static</b>						
Drain-Source Breakdown Voltage	$V_{DS}$	$V_{GS} = 0\text{ V}, I_D = 10\text{ }\mu\text{A}$	60			V
Gate-Threshold Voltage	$V_{GS(th)}$	$V_{DS} = V_{GS}, I_D = 250\text{ }\mu\text{A}$	1		2.5	
Gate-Body Leakage	$I_{GSS}$	$V_{DS} = 0\text{ V}, V_{GS} = \pm 20\text{ V}$			$\pm 10$	$\mu\text{A}$
		$V_{DS} = 0\text{ V}, V_{GS} = \pm 15\text{ V}$			1	
		$V_{DS} = 0\text{ V}, V_{GS} = \pm 10\text{ V}$			$\pm 150$	nA
		$V_{DS} = 0\text{ V}, V_{GS} = \pm 10\text{ V}, T_J = 85\text{ }^\circ\text{C}$			$\pm 1000$	
		$V_{DS} = 0\text{ V}, V_{GS} = \pm 5\text{ V}$			$\pm 100$	
Zero Gate Voltage Drain Current	$I_{DSS}$	$V_{DS} = 60\text{ V}, V_{GS} = 0\text{ V}$			1	$\mu\text{A}$
		$V_{DS} = 60\text{ V}, V_{GS} = 0\text{ V}, T_J = 125\text{ }^\circ\text{C}$			500	
On-State Drain Current <sup>a</sup>	$I_{D(on)}$	$V_{GS} = 10\text{ V}, V_{DS} = 7.5\text{ V}$	700			mA
		$V_{GS} = 4.5\text{ V}, V_{DS} = 10\text{ V}$	300			
Drain-Source On-Resistance <sup>a</sup>	$R_{DS(on)}$	$V_{GS} = 10\text{ V}, I_D = 100\text{ mA}$			2.5	$\Omega$
		$V_{GS} = 4.5\text{ V}, I_D = 100\text{ mA}$			4	
Forward Transconductance <sup>a</sup>	$g_{fs}$	$V_{DS} = 10\text{ V}, I_D = 100\text{ mA}$	100			mS
Diode Forward Voltage	$V_{SD}$	$I_S = 100\text{ mA}, V_{GS} = 0\text{ V}$			1.3	V
<b>Dynamic<sup>a</sup></b>						
Total Gate Charge	$Q_g$	$V_{DS} = 10\text{ V}, V_{GS} = 4.5\text{ V}$ $I_D \cong 100\text{ mA}$		0.4	0.6	nC
Input Capacitance	$C_{iss}$	$V_{DS} = 25\text{ V}, V_{GS} = 0\text{ V}$ $f = 1\text{ MHz}$		30		pF
Output Capacitance	$C_{oss}$			6		
Reverse Transfer Capacitance	$C_{rss}$			2.5		
<b>Switching<sup>a, b, c</sup></b>						
Turn-On Time	$t_{d(on)}$	$V_{DD} = 30\text{ V}, R_L = 150\text{ }\Omega$ $I_D \cong 100\text{ mA}, V_{GEN} = 10\text{ V}, R_G = 10\text{ }\Omega$			25	ns
Turn-Off Time	$t_{d(off)}$				35	

Notes:

- For DESIGN AID ONLY, not subject to production testing.
- Pulse test:  $PW \leq 300\text{ }\mu\text{s}$  duty cycle  $\leq 2\%$ .
- Switching time is essentially independent of operating temperature.

Stresses beyond those listed under "Absolute Maximum Ratings" may cause permanent damage to the device. These are stress ratings only, and functional operation of the device at these or any other conditions beyond those indicated in the operational sections of the specifications is not implied. Exposure to absolute maximum rating conditions for extended periods may affect device reliability.

**TYPICAL CHARACTERISTICS** 25 °C, unless otherwise noted

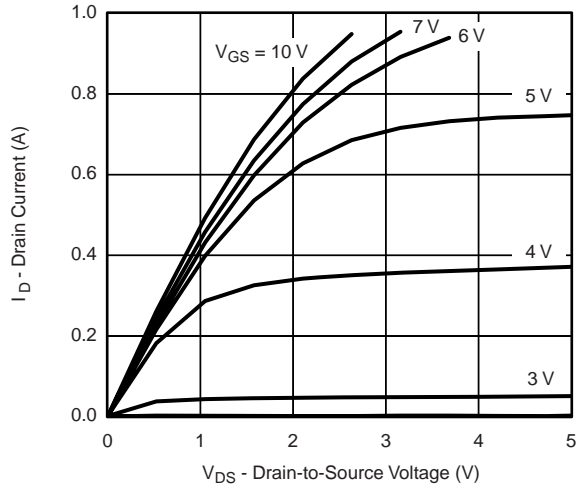

**Output Characteristics**

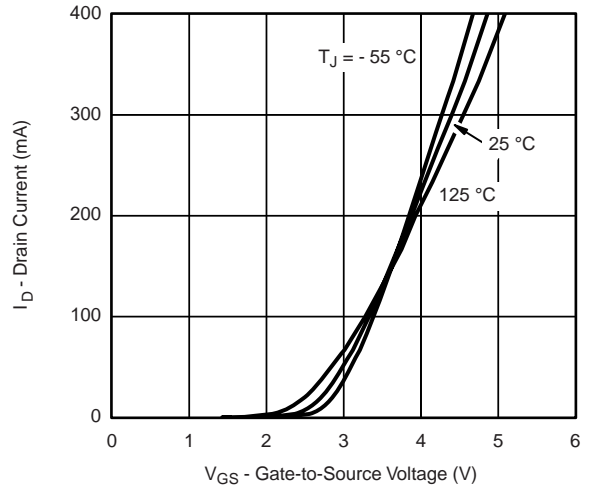

**Transfer Characteristics**

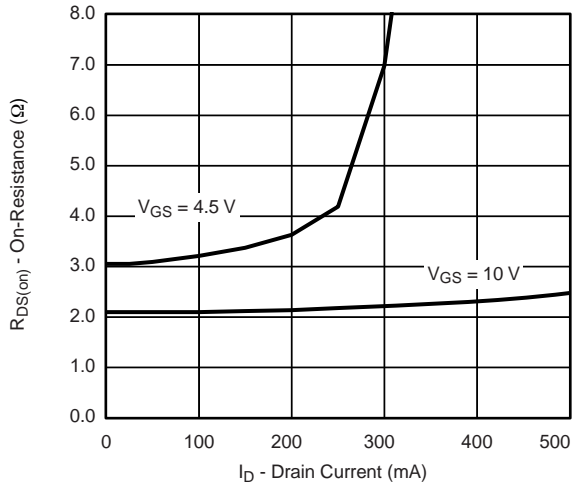

**On-Resistance vs. Drain Current**

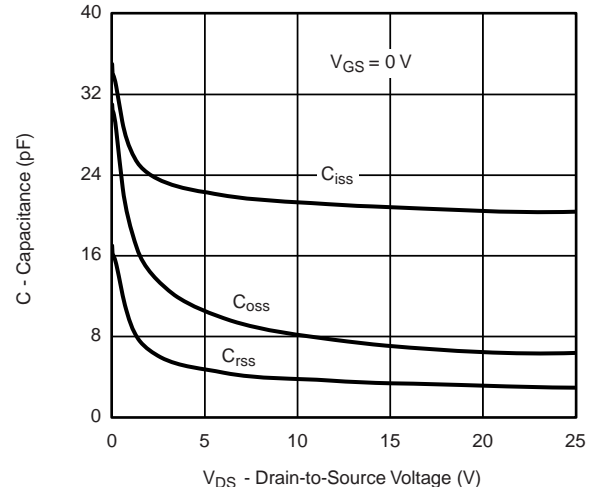

**Capacitance**

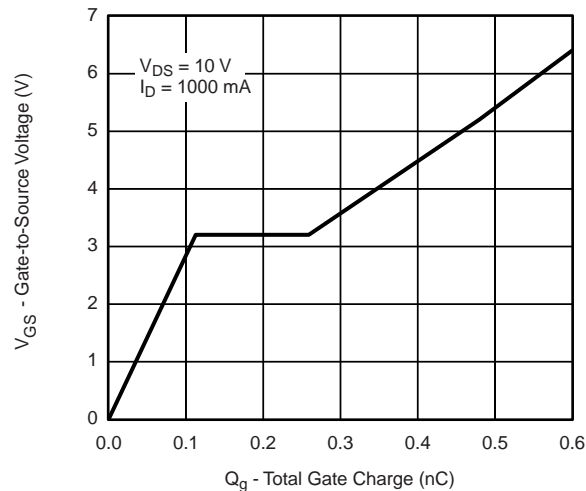

**Gate Charge**

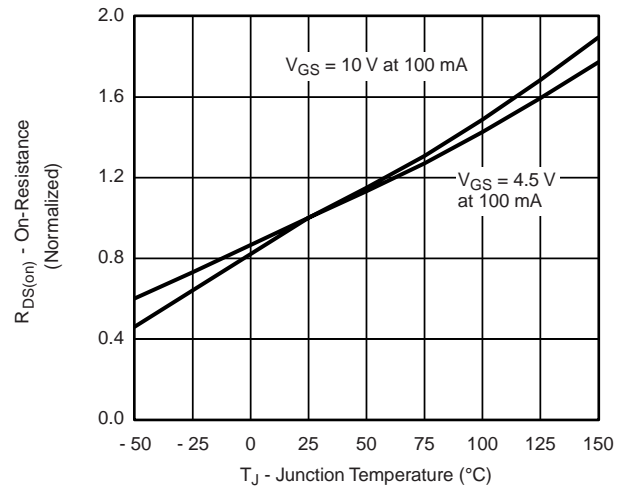

**On-Resistance vs. Junction Temperature**

**TYPICAL CHARACTERISTICS** 25 °C, unless otherwise noted

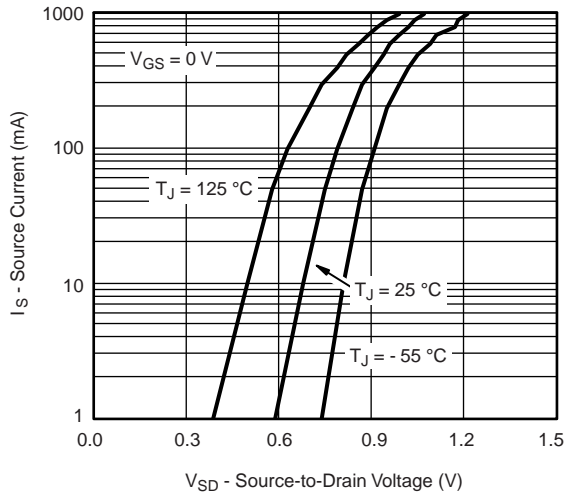

**Source-Drain Diode Forward Voltage**

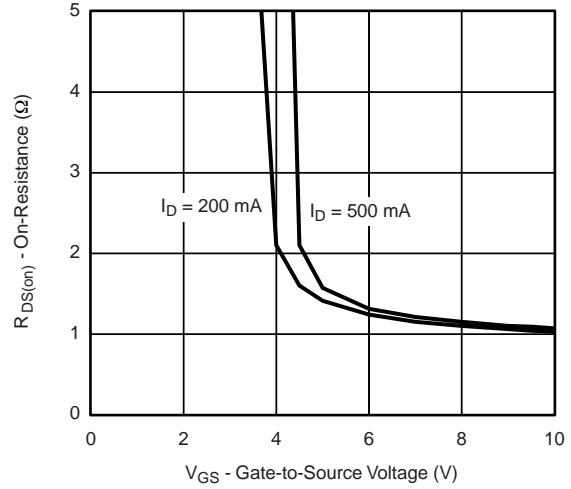

**On-Resistance vs. Gate-Source Voltage**

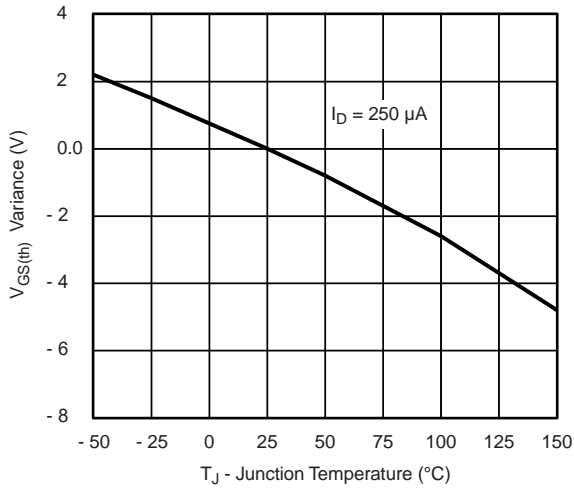

**Threshold Voltage Variance Over Temperature**

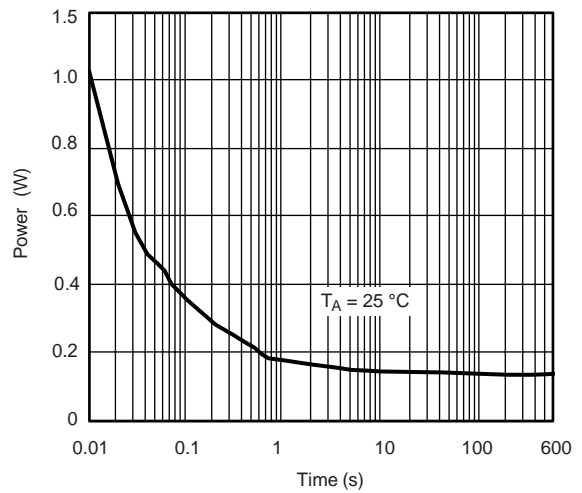

**Single Pulse Power, Junction-to-Ambient**

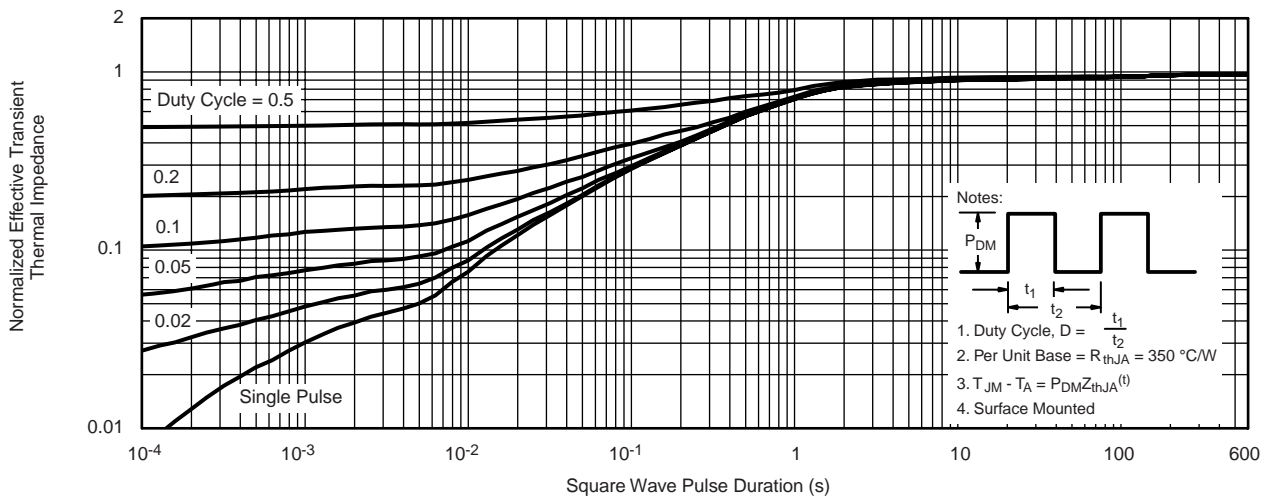

**Normalized Thermal Transient Impedance, Junction-to-Ambient**

- Notes:
1. Duty Cycle,  $D = \frac{t_1}{t_2}$
  2. Per Unit Base =  $R_{thJA} = 350^\circ\text{C/W}$
  3.  $T_{JM} - T_A = P_{DM}Z_{thJA}^{(t)}$
  4. Surface Mounted

**THERMAL RATINGS** ( $T_A = 25\text{ }^\circ\text{C}$ , unless otherwise noted)

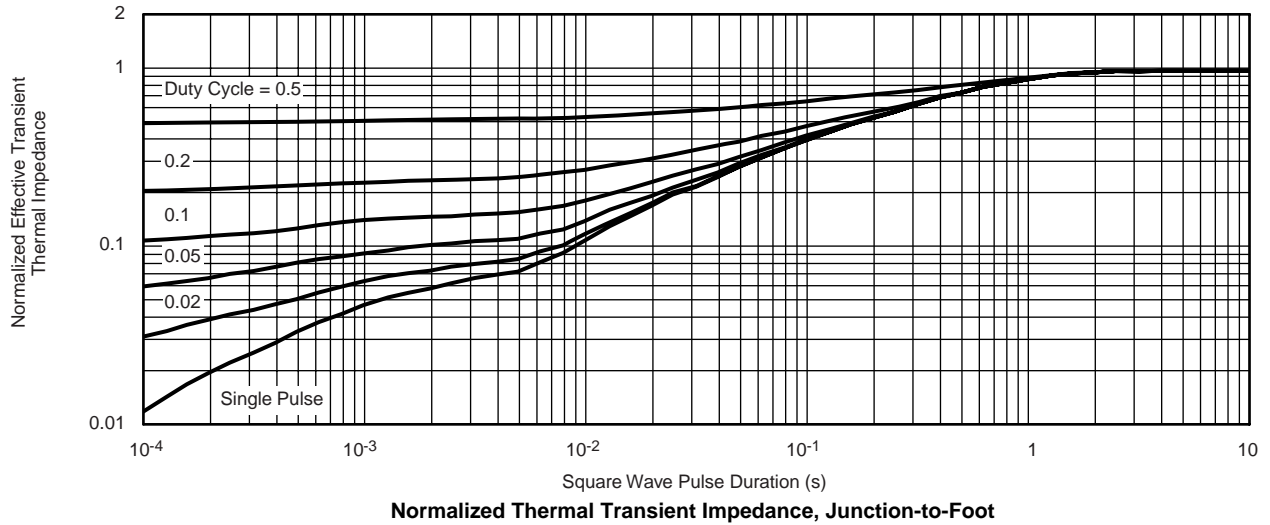

**Normalized Thermal Transient Impedance, Junction-to-Foot**

**Note**

- The characteristics shown in the two graphs
  - Normalized Transient Thermal Impedance Junction-to-Ambient ( $25\text{ }^\circ\text{C}$ )
  - Normalized Transient Thermal Impedance Junction-to-Foot ( $25\text{ }^\circ\text{C}$ )
 are given for general guidelines only to enable the user to get a "ball park" indication of part capabilities. The data are extracted from single pulse transient thermal impedance characteristics which are developed from empirical measurements. The latter is valid for the part mounted on printed circuit board - FR4, size 1" x 1" x 0.062", double sided with 2 oz. copper, 100 % on both sides. The part capabilities can widely vary depending on actual application parameters and operating conditions.

### SOT-523: 3 Leads

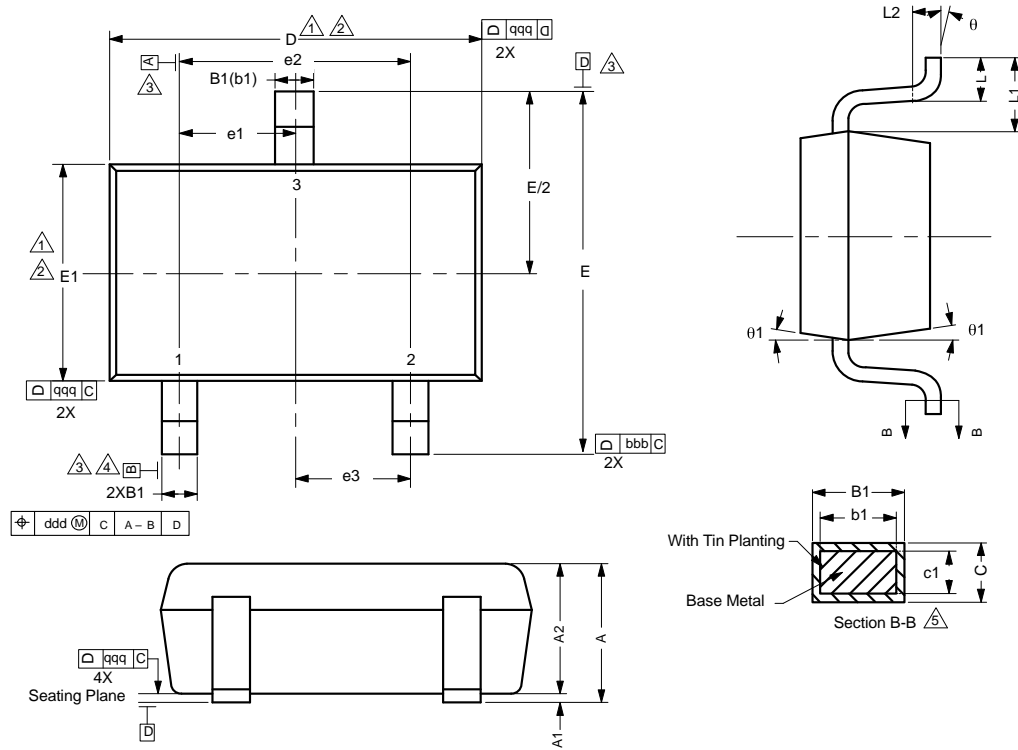

**Notes**

Dimensions in millimeters will govern.

1. Dimension D does not include mold flash, protrusions or gate burrs. Mold flash protrusions or gate burrs shall not exceed 0.10 mm per end. Dimension E1 does not include Interlead flash or protrusion. Interlead flash or protrusion shall not exceed 0.10 mm per side.
2. Dimensions D and E1 are determined at the outmost extremes of the plastic body exclusive of mold flash, tie bar burrs, gate burrs and interlead flash, but including any mismatch between the top and bottom of the plastic body.
3. Datums A, B and D to be determined 0.10 mm from the lead tip.
4. Terminal positions are shown for reference only.
5. These dimensions apply to the flat section of the lead between 0.08 mm and 0.15 mm from the lead tip.

DIMENSIONS	TOLERANCES
aaa	0.10
bbb	0.10
ccc	0.10
ddd	0.10

DIM.	MILLIMETERS			NOTE
	MIN.	NOM.	MAX.	
A	-	-	0.80	
A <sub>1</sub>	0.00	-	0.10	
A <sub>2</sub>	0.65	0.70	0.80	
B <sub>1</sub>	0.19	-	0.24	5
b <sub>1</sub>	0.17	-	0.21	
c	0.13	-	0.15	5
c <sub>1</sub>	0.10	-	0.12	5
D	1.48	1.575	1.68	1, 2
E	1.50	1.60	1.70	
E <sub>1</sub>	0.66	0.76	0.86	1, 2
e <sub>1</sub>	0.50 BSC			
e <sub>2</sub>	1.00 BSC			
e <sub>3</sub>	0.50 BSC			
L	0.15	0.205	0.30	
L <sub>1</sub>	0.40 ref.			
L <sub>2</sub>	0.15 BSC			
$\theta$	0°	-	8°	
$\theta_1$	4°	-	10°	

**RECOMMENDED MINIMUM PADS FOR SC-75A: 3-Lead**

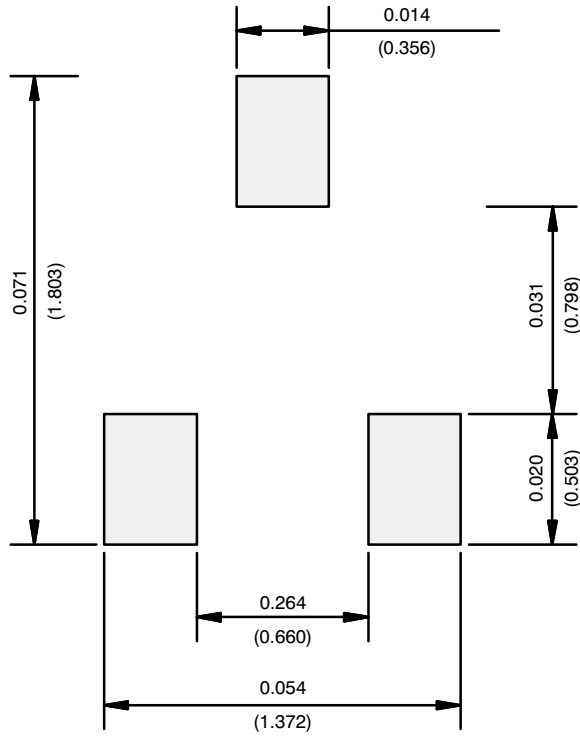

Recommended Minimum Pads  
Dimensions in Inches/(mm)

## Disclaimer

ALL PRODUCT, PRODUCT SPECIFICATIONS AND DATA ARE SUBJECT TO CHANGE WITHOUT NOTICE TO IMPROVE RELIABILITY, FUNCTION OR DESIGN OR OTHERWISE.

Din-Tek Intertechnology, Inc., its affiliates, agents, and employees, and all persons acting on its or their behalf (collectively, "Din-Tek"), disclaim any and all liability for any errors, inaccuracies or incompleteness contained in any datasheet or in any other disclosure relating to any product.

Din-Tek makes no warranty, representation or guarantee regarding the suitability of the products for any particular purpose or the continuing production of any product. To the maximum extent permitted by applicable law, Din-Tek disclaims (i) any and all liability arising out of the application or use of any product, (ii) any and all liability, including without limitation special, consequential or incidental damages, and (iii) any and all implied warranties, including warranties of fitness for particular purpose, non-infringement and merchantability.

Statements regarding the suitability of products for certain types of applications are based on Din-Tek's knowledge of typical requirements that are often placed on Din-Tek products in generic applications. Such statements are not binding statements about the suitability of products for a particular application. It is the customer's responsibility to validate that a particular product with the properties described in the product specification is suitable for use in a particular application. Parameters provided in datasheets and/or specifications may vary in different applications and performance may vary over time. All operating parameters, including typical parameters, must be validated for each customer application by the customer's technical experts. Product specifications do not expand or otherwise modify Din-Tek's terms and conditions of purchase, including but not limited to the warranty expressed therein.

Except as expressly indicated in writing, Din-Tek products are not designed for use in medical, life-saving, or life-sustaining applications or for any other application in which the failure of the Din-Tek product could result in personal injury or death. Customers using or selling Din-Tek products not expressly indicated for use in such applications do so at their own risk. Please contact authorized Din-Tek personnel to obtain written terms and conditions regarding products designed for such applications.

No license, express or implied, by estoppel or otherwise, to any intellectual property rights is granted by this document or by any conduct of Din-Tek. Product names and markings noted herein may be trademarks of their respective owners.

## Material Category Policy

**Din-Tek Intertechnology, Inc. hereby certifies that all its products that are identified as RoHS-Compliant fulfill the definitions and restrictions defined under Directive 2011/65/EU of The European Parliament and of the Council of June 8, 2011 on the restriction of the use of certain hazardous substances in electrical and electronic equipment (EEE) - recast, unless otherwise specified as non-compliant.**

**Please note that some Din-Tek documentation may still make reference to RoHS Directive 2002/95/EC. We confirm that all the products identified as being compliant to Directive 2002/95/EC conform to Directive 2011/65/EU.**

**Din-Tek Intertechnology, Inc. hereby certifies that all its products that are identified as Halogen-Free follow Halogen-Free requirements as per JEDEC JS709A standards. Please note that some Din-Tek documentation may still make reference to the IEC 61249-2-21 definition. We confirm that all the products identified as being compliant to IEC 61249-2-21 conform to JEDEC JS709A standards.**