

Power MOSFET

PRODUCT SUMMARY		
V_{DS} (V)	250	
$R_{DS(on)}$ (Ω)	$V_{GS} = 10\text{ V}$	0.209
Q_g (Max.) (nC)	75	
Q_{gs} (nC)	13	
Q_{gd} (nC)	39	
Configuration	Single	

FEATURES

- Surface Mount
- Low-Profile Through-Hole
- Available in Tape and Reel
- Dynamic dV/dt Rating
- 150 °C Operating Temperature
- Fast Switching
- Fully Avalanche Rated
- Compliant to RoHS Directive 2002/95/EC

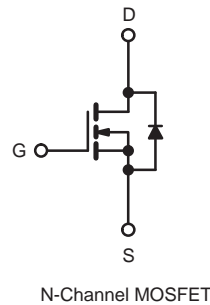
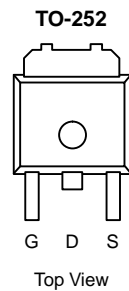

ABSOLUTE MAXIMUM RATINGS ($T_C = 25\text{ }^\circ\text{C}$, unless otherwise noted)				
PARAMETER	SYMBOL		LIMIT	UNIT
Drain-Source Voltage	V_{DS}		250	V
Gate-Source Voltage	V_{GS}		± 20	
Continuous Drain Current	V_{GS} at 10 V	$T_C = 25\text{ }^\circ\text{C}$	16	A
		$T_C = 100\text{ }^\circ\text{C}$	13	
Pulsed Drain Current ^{a, e}	I_{DM}		62	
Linear Derating Factor			1.0	W/°C
Single Pulse Avalanche Energy ^{b, e}	E_{AS}		420	mJ
Avalanche Current ^a	I_{AR}		10	A
Repetitive Avalanche Energy ^a	E_{AR}		13	mJ
Maximum Power Dissipation	$T_C = 25\text{ }^\circ\text{C}$		3.1	W
	$T_A = 25\text{ }^\circ\text{C}$		130	
Peak Diode Recovery dV/dt ^{c, e}	dV/dt		5.0	V/ns
Operating Junction and Storage Temperature Range	T_J, T_{stg}		- 55 to + 150	°C
Soldering Recommendations (Peak Temperature)	for 10 s		300 ^d	

Notes

- Repetitive rating; pulse width limited by maximum junction temperature (see fig. 11).
- $V_{DD} = 50\text{ V}$, starting $T_J = 25\text{ }^\circ\text{C}$, $L = 2.7\text{ mH}$, $R_g = 25\text{ }\Omega$, $I_{AS} = 12\text{ A}$ (see fig. 12).
- $I_{SD} \leq 20\text{ A}$, $dI/dt \leq 150\text{ A}/\mu\text{s}$, $V_{DD} \leq V_{DS}$, $T_J \leq 150\text{ }^\circ\text{C}$.
- 1.6 mm from case.

* Pb containing terminations are not RoHS compliant, exemptions may apply

THERMAL RESISTANCE RATINGS				
PARAMETER	SYMBOL	TYP.	MAX.	UNIT
Maximum Junction-to-Ambient (PCB Mounted, Steady-State) ^a	R _{thJA}	-	40	°C/W
Maximum Junction-to-Case (Drain)	R _{thJC}	-	1.0	

Note

a. When mounted on 1" square PCB (FR-4 or G-10 material).

SPECIFICATIONS (T _J = 25 °C, unless otherwise noted)							
PARAMETER	SYMBOL	TEST CONDITIONS		MIN.	TYP.	MAX.	UNIT
Static							
Drain-Source Breakdown Voltage	V _{DS}	V _{GS} = 0 V, I _D = 250 μA		250	-	-	V
V _{DS} Temperature Coefficient	ΔV _{DS} /T _J	Reference to 25 °C, I _D = 1 mA ^c		-	0.29	-	V/°C
Gate-Source Threshold Voltage	V _{GS(th)}	V _{DS} = V _{GS} , I _D = 250 μA		3.0	-	5.0	V
Gate-Source Leakage	I _{GSS}	V _{GS} = ± 20 V		-	-	± 100	nA
Zero Gate Voltage Drain Current	I _{DSS}	V _{DS} = 200 V, V _{GS} = 0 V		-	-	25	μA
		V _{DS} = 160 V, V _{GS} = 0 V, T _J = 125 °C		-	-	250	
Drain-Source On-State Resistance	R _{DS(on)}	V _{GS} = 10 V	I _D = 11 A ^b	-	-	0.209	Ω
Forward Transconductance	g _{fs}	V _{DS} = 50 V, I _D = 11 A ^d		6.7	-	-	S
Dynamic							
Input Capacitance	C _{iss}	V _{GS} = 0 V, V _{DS} = 25 V, f = 1.0 MHz, see fig. 5 ^d		-	1300	-	pF
Output Capacitance	C _{oss}			-	430	-	
Reverse Transfer Capacitance	C _{rss}			-	130	-	
Total Gate Charge	Q _g	V _{GS} = 10 V	I _D = 12 A, V _{DS} = 160 V, see fig. 6 and 13 ^{b, c}	-	-	75	nC
Gate-Source Charge	Q _{gs}			-	-	13	
Gate-Drain Charge	Q _{gd}			-	-	39	
Turn-On Delay Time	t _{d(on)}	V _{DD} = 100 V, I _D = 20 A, R _g = 9.1 Ω, R _D = 5.4 Ω, see fig. 10 ^{b, c}		-	14	-	ns
Rise Time	t _r			-	51	-	
Turn-Off Delay Time	t _{d(off)}			-	45	-	
Fall Time	t _f			-	36	-	
Drain-Source Body Diode Characteristics							
Continuous Source-Drain Diode Current	I _S	MOSFET symbol showing the integral reverse p - n junction diode 		-	-	16	A
Pulsed Diode Forward Current ^a	I _{SM}			-	-	72	
Body Diode Voltage	V _{SD}	T _J = 25 °C, I _S = 20 A, V _{GS} = 0 V ^b		-	-	2.0	V
Body Diode Reverse Recovery Time	t _{rr}	T _J = 25 °C, I _F = 20 A, di/dt = 100 A/μs ^{b, c}		-	300	610	ns
Body Diode Reverse Recovery Charge	Q _{rr}			-	3.4	7.1	μC
Forward Turn-On Time	t _{on}	Intrinsic turn-on time is negligible (turn-on is dominated by L _S and L _D)					

Notes

- a. Repetitive rating; pulse width limited by maximum junction temperature (see fig. 11).
- b. Pulse width ≤ 300 μs; duty cycle ≤ 2 %.
- c. Uses IRF640/SiHF640 data and test conditions.

TYPICAL CHARACTERISTICS (25 °C, unless otherwise noted)

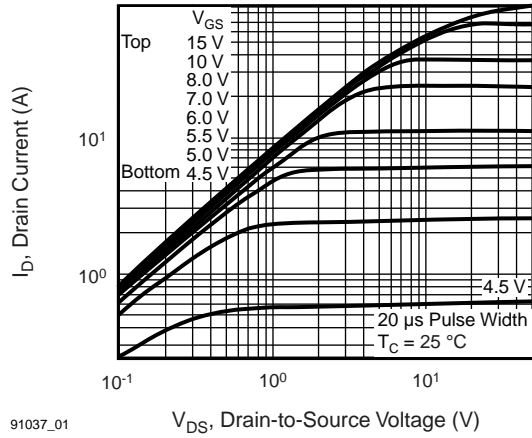

91037_01

Fig. 1 - Typical Output Characteristics, $T_J = 25\text{ }^\circ\text{C}$

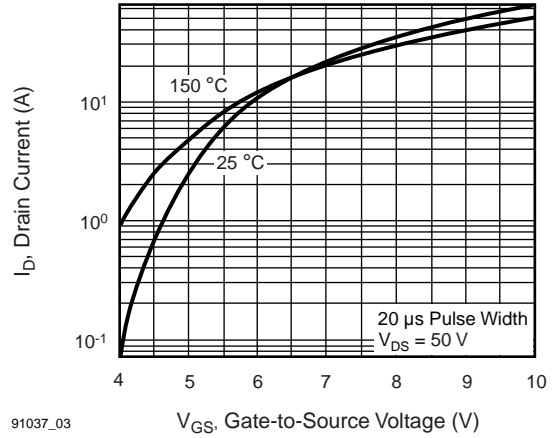

91037_03

Fig. 3 - Typical Transfer Characteristics

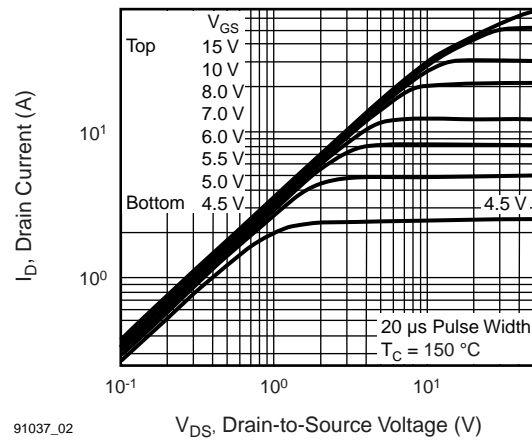

91037_02

Fig. 2 - Typical Output Characteristics, $T_J = 175\text{ }^\circ\text{C}$

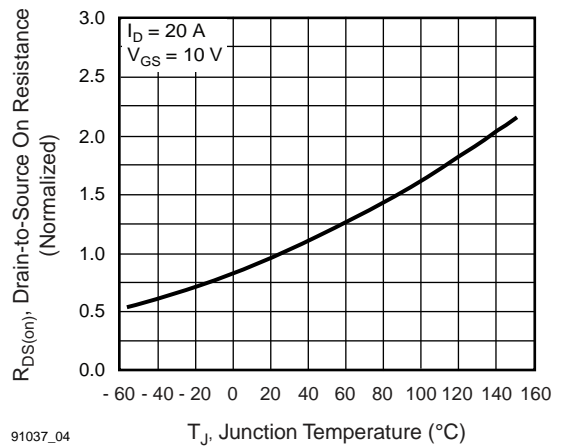

91037_04

Fig. 4 - Normalized On-Resistance vs. Temperature

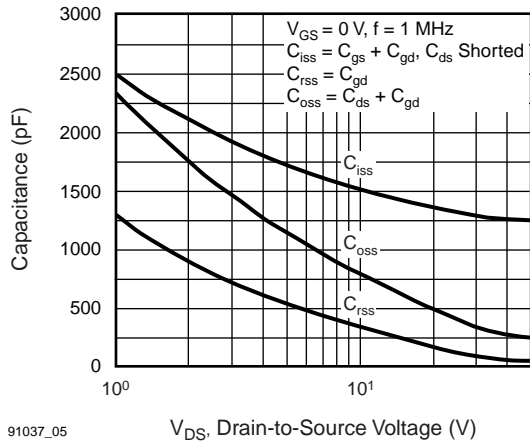

Fig. 5 - Typical Capacitance vs. Drain-to-Source Voltage

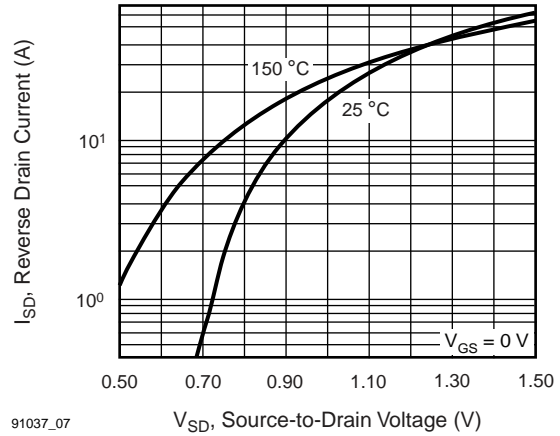

Fig. 7 - Typical Source-Drain Diode Forward Voltage

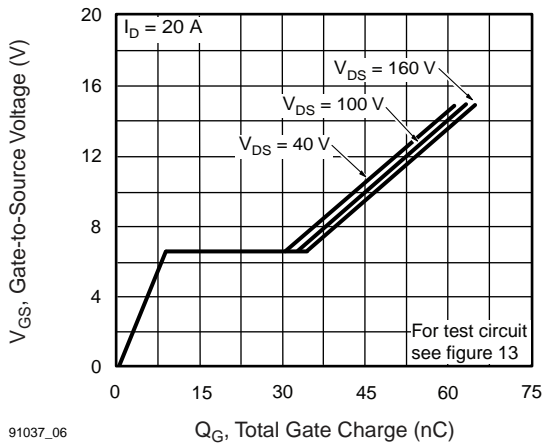

Fig. 6 - Typical Gate Charge vs. Gate-to-Source Voltage

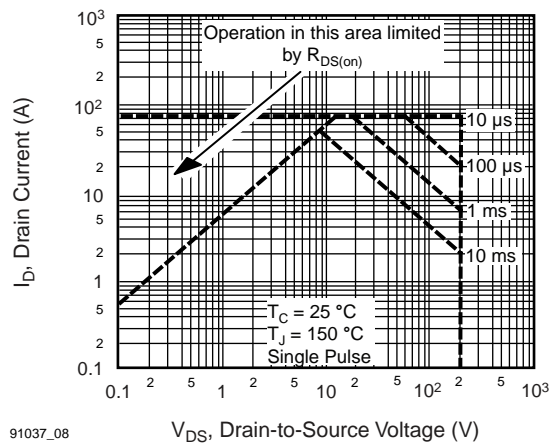
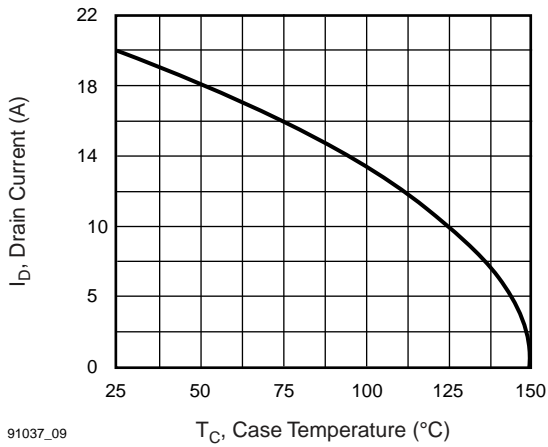

Fig. 8 - Maximum Safe Operating Area



91037_09

Fig. 9 - Maximum Drain Current vs. Case Temperature

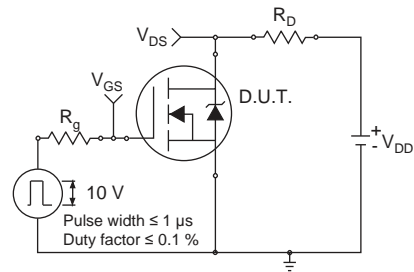

Fig. 10a - Switching Time Test Circuit

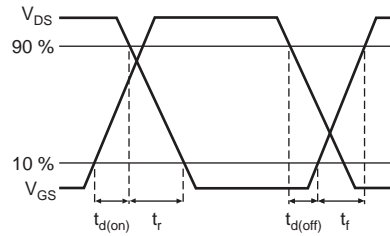
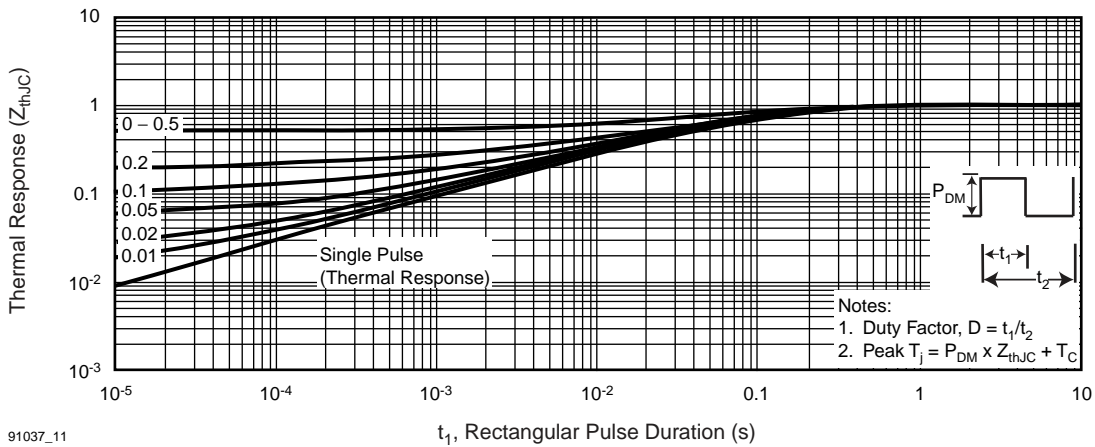

Fig. 10b - Switching Time Waveforms



91037_11

Fig. 11 - Maximum Effective Transient Thermal Impedance, Junction-to-Case



Fig. 12a - Unclamped Inductive Test Circuit

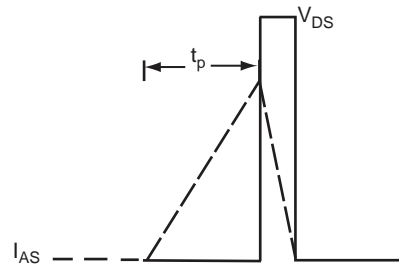
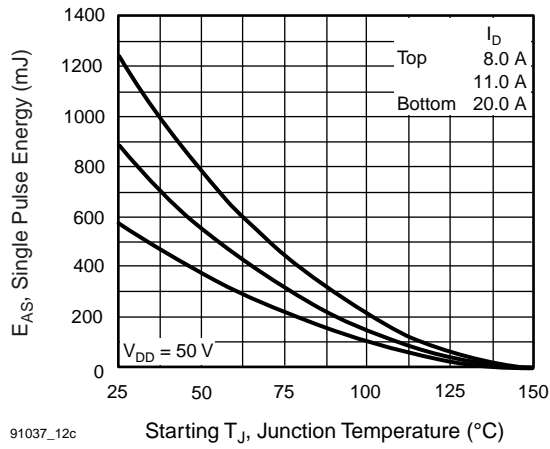

Fig. 12b - Unclamped Inductive Waveforms



91037_12c

Fig. 12c - Maximum Avalanche Energy vs. Drain Current

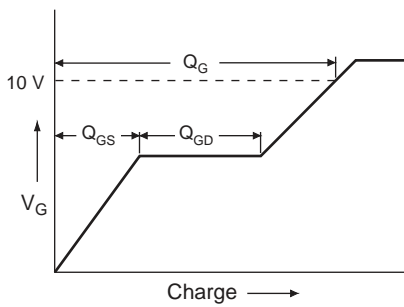

Fig. 13a - Basic Gate Charge Waveform

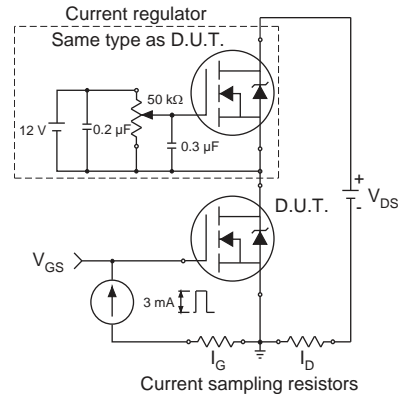
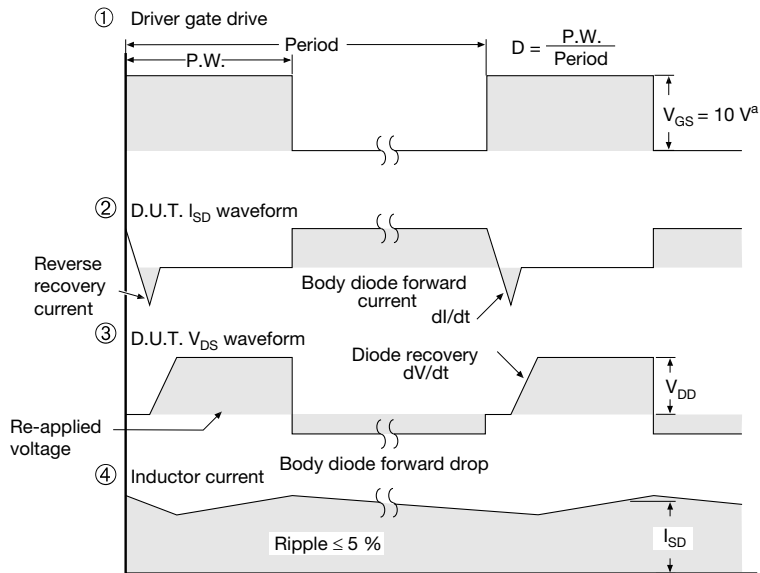
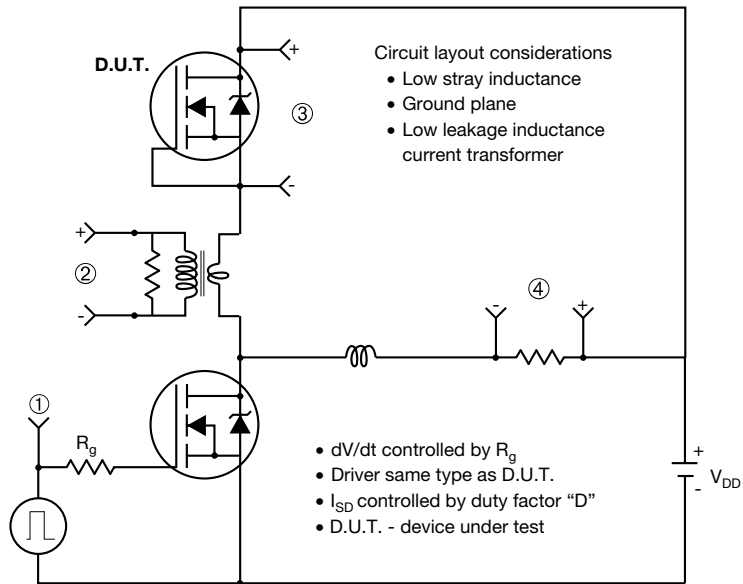

Fig. 13b - Gate Charge Test Circuit

Peak Diode Recovery dV/dt Test Circuit



Note

a. $V_{GS} = 5 V$ for logic level devices

Fig. 14 - For N-Channel

TO-252AA CASE OUTLINE

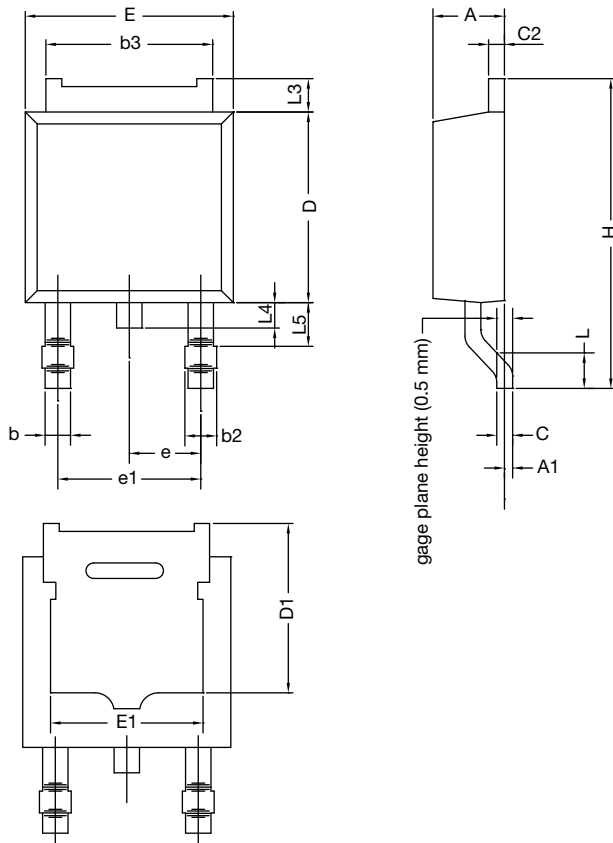

DIM.	MILLIMETERS		INCHES	
	MIN.	MAX.	MIN.	MAX.
A	2.18	2.38	0.086	0.094
A1	-	0.127	-	0.005
b	0.64	0.88	0.025	0.035
b2	0.76	1.14	0.030	0.045
b3	4.95	5.46	0.195	0.215
C	0.46	0.61	0.018	0.024
C2	0.46	0.89	0.018	0.035
D	5.97	6.22	0.235	0.245
D1	5.21	-	0.205	-
E	6.35	6.73	0.250	0.265
E1	4.32	-	0.170	-
H	9.40	10.41	0.370	0.410
e	2.28 BSC		0.090 BSC	
e1	4.56 BSC		0.180 BSC	
L	1.40	1.78	0.055	0.070
L3	0.89	1.27	0.035	0.050
L4	-	1.02	-	0.040
L5	1.14	1.52	0.045	0.060
ECN: X12-0247-Rev. M, 24-Dec-12 DWG: 5347				

Note

- Dimension L3 is for reference only.

RECOMMENDED MINIMUM PADS FOR DPAK (TO-252)

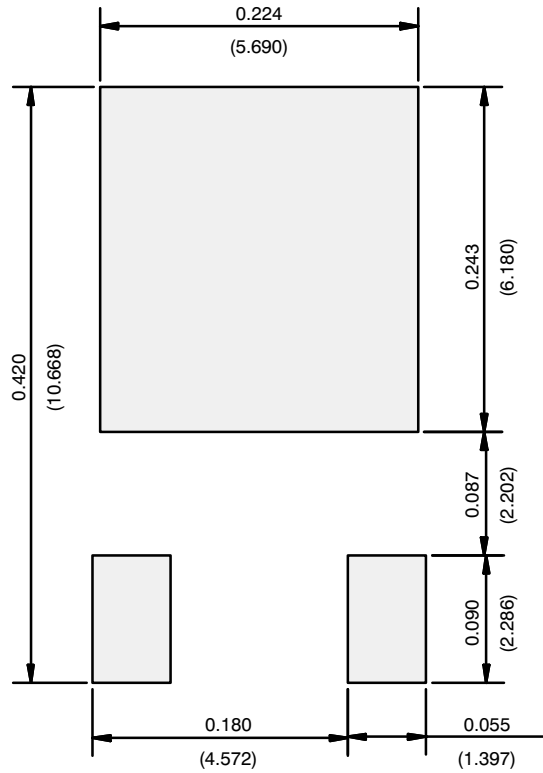

Recommended Minimum Pads
Dimensions in Inches/(mm)

Disclaimer

ALL PRODUCT, PRODUCT SPECIFICATIONS AND DATA ARE SUBJECT TO CHANGE WITHOUT NOTICE TO IMPROVE RELIABILITY, FUNCTION OR DESIGN OR OTHERWISE.

Din-Tek Intertechnology, Inc., its affiliates, agents, and employees, and all persons acting on its or their behalf (collectively, "Din-Tek"), disclaim any and all liability for any errors, inaccuracies or incompleteness contained in any datasheet or in any other disclosure relating to any product.

Din-Tek makes no warranty, representation or guarantee regarding the suitability of the products for any particular purpose or the continuing production of any product. To the maximum extent permitted by applicable law, Din-Tek disclaims (i) any and all liability arising out of the application or use of any product, (ii) any and all liability, including without limitation special, consequential or incidental damages, and (iii) any and all implied warranties, including warranties of fitness for particular purpose, non-infringement and merchantability.

Statements regarding the suitability of products for certain types of applications are based on Din-Tek's knowledge of typical requirements that are often placed on Din-Tek products in generic applications. Such statements are not binding statements about the suitability of products for a particular application. It is the customer's responsibility to validate that a particular product with the properties described in the product specification is suitable for use in a particular application. Parameters provided in datasheets and/or specifications may vary in different applications and performance may vary over time. All operating parameters, including typical parameters, must be validated for each customer application by the customer's technical experts. Product specifications do not expand or otherwise modify Din-Tek's terms and conditions of purchase, including but not limited to the warranty expressed therein.

Except as expressly indicated in writing, Din-Tek products are not designed for use in medical, life-saving, or life-sustaining applications or for any other application in which the failure of the Din-Tek product could result in personal injury or death. Customers using or selling Din-Tek products not expressly indicated for use in such applications do so at their own risk. Please contact authorized Din-Tek personnel to obtain written terms and conditions regarding products designed for such applications.

No license, express or implied, by estoppel or otherwise, to any intellectual property rights is granted by this document or by any conduct of Din-Tek. Product names and markings noted herein may be trademarks of their respective owners.

Material Category Policy

Din-Tek Intertechnology, Inc. hereby certifies that all its products that are identified as RoHS-Compliant fulfill the definitions and restrictions defined under Directive 2011/65/EU of The European Parliament and of the Council of June 8, 2011 on the restriction of the use of certain hazardous substances in electrical and electronic equipment (EEE) - recast, unless otherwise specified as non-compliant.

Please note that some Din-Tek documentation may still make reference to RoHS Directive 2002/95/EC. We confirm that all the products identified as being compliant to Directive 2002/95/EC conform to Directive 2011/65/EU.

Din-Tek Intertechnology, Inc. hereby certifies that all its products that are identified as Halogen-Free follow Halogen-Free requirements as per JEDEC JS709A standards. Please note that some Din-Tek documentation may still make reference to the IEC 61249-2-21 definition. We confirm that all the products identified as being compliant to IEC 61249-2-21 conform to JEDEC JS709A standards.