

N-Channel 25 V (D-S) MOSFET



RoHS
COMPLIANT

PRODUCT SUMMARY			
V _{DS} (V)	R _{DS(on)} (Ω) MAX.	I _D (A) ^c	Q _g (TYP.)
25	0.225 at V _{GS} = 10 V	0.7	1.4 nC
	0.265 at V _{GS} = 4.5 V	0.6	
	0.369 at V _{GS} = 2.5 V	0.4	

FEATURES

- DT-Trench Power MOSFET
- 100 % R_g Tested
- Compliant to RoHS Directive 2002/95/EC

APPLICATIONS

- Smart phones, tablet PC's
 - DC/DC converters
 - Boost converters
 - Load switch, OVP switch

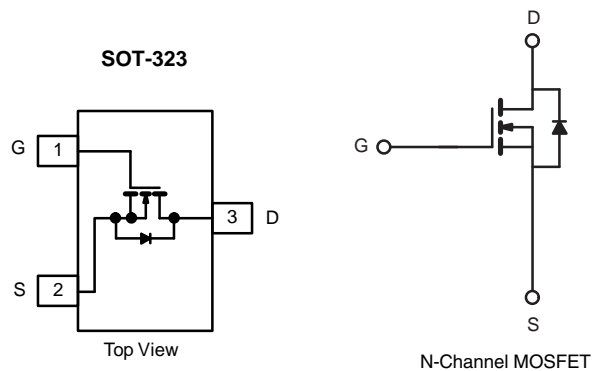

ABSOLUTE MAXIMUM RATINGS (T _A = 25 °C, unless otherwise noted)				
PARAMETER	SYMBOL	LIMIT	UNIT	
Drain-Source Voltage	V _{DS}	25	V	
Gate-Source Voltage	V _{GS}	± 10		
Continuous Drain Current (T _J = 150 °C)	I _D	T _C = 25 °C	0.7	A
		T _C = 70 °C	0.5	
		T _A = 25 °C	0.65 ^{a, b}	
		T _A = 70 °C	0.46 ^{a, b}	
Pulsed Drain Current (t = 300 μs)	I _{DM}	2.8		
Continuous Source-Drain Diode Current	I _S	T _C = 25 °C	0.7	
		T _A = 25 °C	0.3	
Maximum Power Dissipation	P _D	T _C = 25 °C	0.27	W
		T _C = 70 °C	0.15	
		T _A = 25 °C	0.2 ^{a, b}	
		T _A = 70 °C	0.11 ^{a, b}	
Operating Junction and Storage Temperature Range	T _J , T _{stg}	-55 to +150	°C	
Soldering Recommendations (Peak Temperature)		260		

Notes

- Surface mounted on 1" x 1" FR4 board.
- t = 10 s.
- Based on T_C = 25 °C.

SPECIFICATIONS ($T_J = 25\text{ }^\circ\text{C}$, unless otherwise noted)						
PARAMETER	SYMBOL	TEST CONDITIONS	MIN.	TYP.	MAX.	UNIT
Static						
Drain-Source Breakdown Voltage	V_{DS}	$V_{GS} = 0\text{ V}, I_D = 250\text{ }\mu\text{A}$	25	-	-	V
V_{DS} Temperature Coefficient	$\Delta V_{DS}/T_J$	$I_D = 250\text{ }\mu\text{A}$	-	32	-	mV/ $^\circ\text{C}$
$V_{GS(th)}$ Temperature Coefficient	$\Delta V_{GS(th)}/T_J$		-	-3	-	
Gate-Source Threshold Voltage	$V_{GS(th)}$	$V_{DS} = V_{GS}, I_D = 250\text{ }\mu\text{A}$	0.4	-	1.5	V
Gate-Source Leakage	I_{GSS}	$V_{DS} = 0\text{ V}, V_{GS} = 4.5\text{ V}$	-	-	1	μA
		$V_{DS} = 0\text{ V}, V_{GS} = \pm 12\text{ V}$	-	-	± 20	
Zero Gate Voltage Drain Current	I_{DSS}	$V_{DS} = 20\text{ V}, V_{GS} = 0\text{ V}$	-	-	1	
		$V_{DS} = 20\text{ V}, V_{GS} = 0\text{ V}, T_J = 55\text{ }^\circ\text{C}$	-	-	10	
On-State Drain Current ^a	$I_{D(on)}$	$V_{DS} \geq 5\text{ V}, V_{GS} = 10\text{ V}$	0.7	-	-	A
Drain-Source On-State Resistance ^a	$R_{DS(on)}$	$V_{GS} = 10\text{ V}, I_D = 0.5\text{ A}$	-	0.225	0.132	Ω
		$V_{GS} = 4.5\text{ V}, I_D = 0.3\text{ A}$	-	0.265	0.144	
		$V_{GS} = 2.5\text{ V}, I_D = 0.3\text{ A}$	-	0.369	0.185	
Forward Transconductance ^a	g_{fs}	$V_{DS} = 10\text{ V}, I_D = 0.5\text{ A}$	-	5	-	S
Dynamic ^b						
Input Capacitance	C_{iss}	$V_{DS} = 20\text{ V}, V_{GS} = 0\text{ V}, f = 1\text{ MHz}$	-	185	-	pF
Output Capacitance	C_{oss}		-	43	-	
Reverse Transfer Capacitance	C_{rss}		-	11	-	
Total Gate Charge	Q_g	$V_{DS} = 20\text{ V}, V_{GS} = 10\text{ V}, I_D = 0.5\text{ A}$	-	2.7	4.1	nC
Gate-Source Charge	Q_{gs}	$V_{DS} = 20\text{ V}, V_{GS} = 4.5\text{ V}, I_D = 0.3\text{ A}$	-	1.4	2.1	
Gate-Drain Charge	Q_{gd}		-	0.3	-	
Gate Resistance	R_g		-	0.5	-	
Gate Resistance	R_g	$f = 1\text{ MHz}$	-	7	-	Ω
Turn-On Delay Time	$t_{d(on)}$	$V_{DD} = 20\text{ V}, R_L = 13.6\text{ }\Omega$ $I_D \approx 0.7\text{ A}, V_{GEN} = 10\text{ V}, R_g = 1\text{ }\Omega$	-	2	-	ns
Rise Time	t_r		-	9	-	
Turn-Off Delay Time	$t_{d(off)}$		-	8	-	
Fall Time	t_f		-	8	-	
Turn-On Delay Time	$t_{d(on)}$	$V_{DD} = 20\text{ V}, R_L = 13.6\text{ }\Omega$ $I_D \approx 0.3\text{ A}, V_{GEN} = 4.5\text{ V}, R_g = 1\text{ }\Omega$	-	8	-	
Rise Time	t_r		-	13	-	
Turn-Off Delay Time	$t_{d(off)}$		-	15	-	
Fall Time	t_f		-	6	-	
Drain-Source Body Diode Characteristics						
Continuous Source-Drain Diode Current	I_S	$T_C = 25\text{ }^\circ\text{C}$	-	-	0.7	A
Pulse Diode Forward Current ^a	I_{SM}		-	-	2.8	
Body Diode Voltage	V_{SD}	$I_F = 0.5\text{ A}$	-	0.7	1.2	V
Body Diode Reverse Recovery Time	t_{rr}	$I_F = 0.5\text{ A}, di/dt = 100\text{ A}/\mu\text{s}, T_J = 25\text{ }^\circ\text{C}$	-	8	16	ns
Body Diode Reverse Recovery Charge	Q_{rr}		-	3	6	nC
Reverse Recovery Fall Time	t_a		-	5	-	ns
Reverse Recovery Rise Time	t_b		-	3	-	

Notes

- a. Pulse test; pulse width $\leq 300\text{ }\mu\text{s}$, duty cycle $\leq 2\%$.
 b. Guaranteed by design, not subject to production testing.

Stresses beyond those listed under "Absolute Maximum Ratings" may cause permanent damage to the device. These are stress ratings only, and functional operation of the device at these or any other conditions beyond those indicated in the operational sections of the specifications is not implied. Exposure to absolute maximum ratings conditions for extended periods may affect device reliability.

TYPICAL CHARACTERISTICS (25 °C, unless otherwise noted)

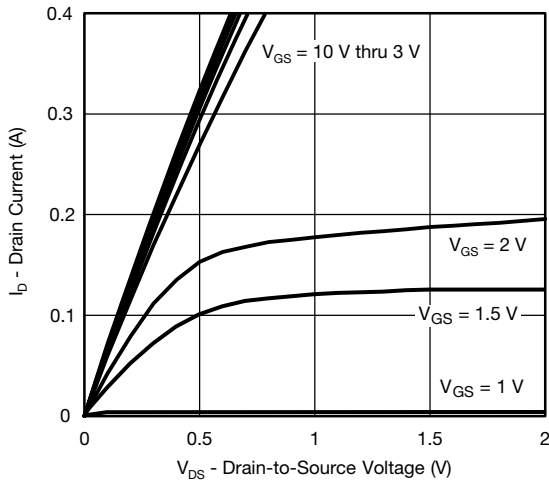

Output Characteristics

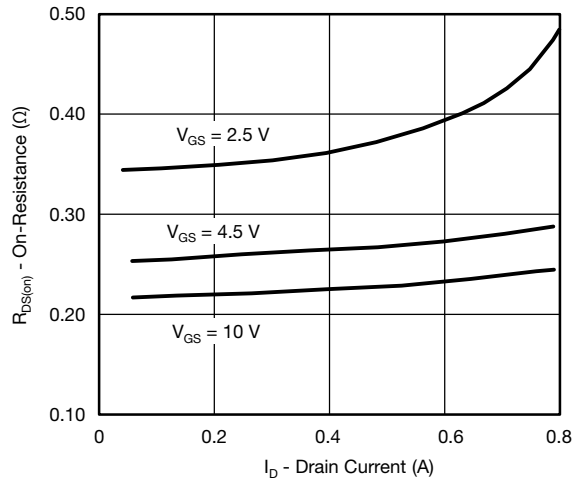

On-Resistance vs. Drain Current

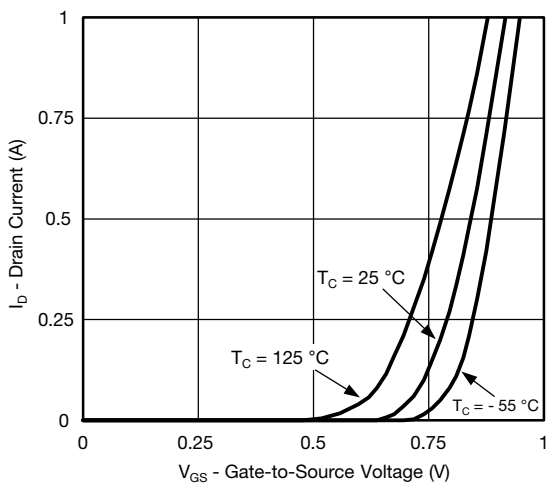

Transfer Characteristics

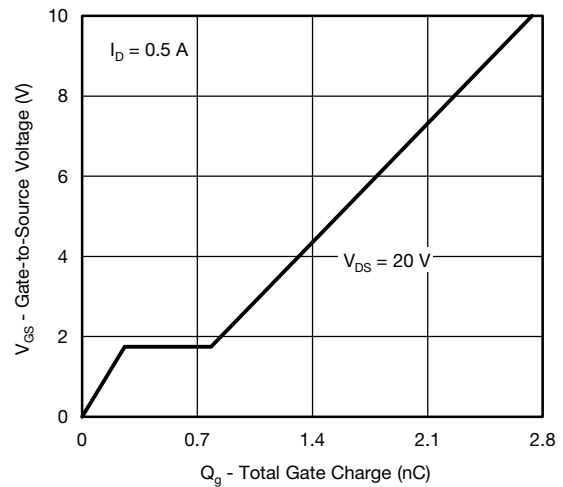

Gate Charge

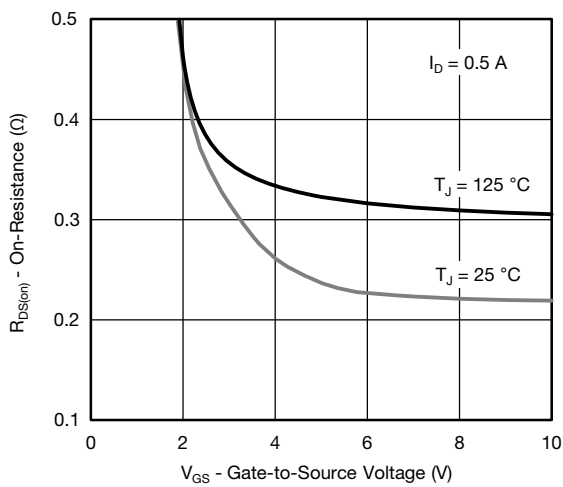

On-Resistance vs. Gate-to-Source Voltage

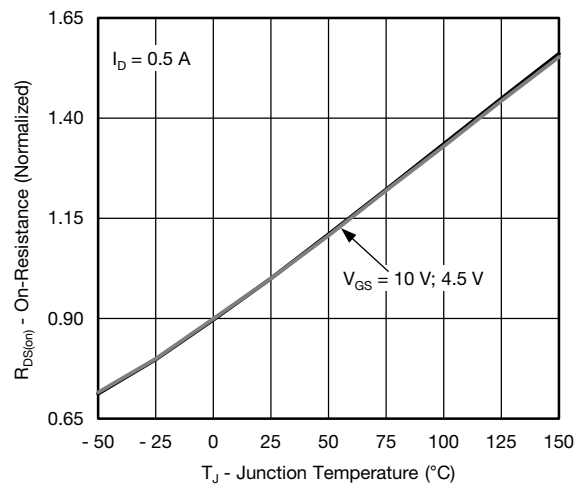

On-Resistance vs. Junction Temperature

TYPICAL CHARACTERISTICS (25 °C, unless otherwise noted)

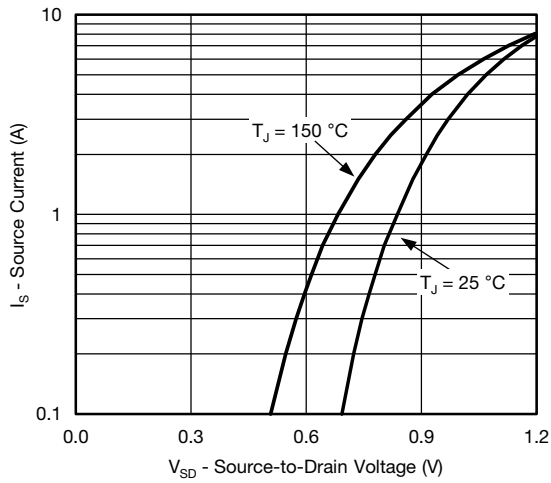

Source-Drain Diode Forward Voltage

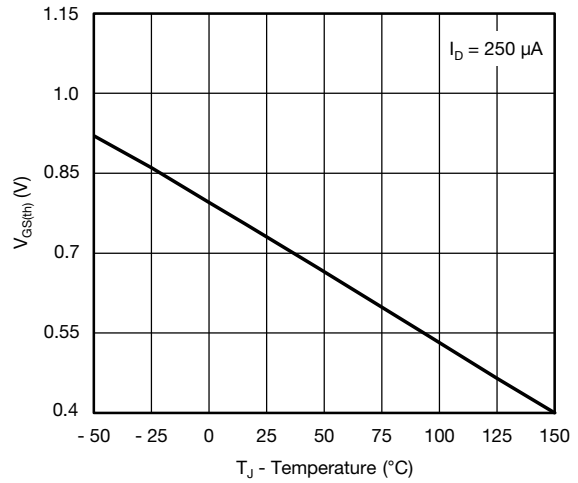

Threshold Voltage

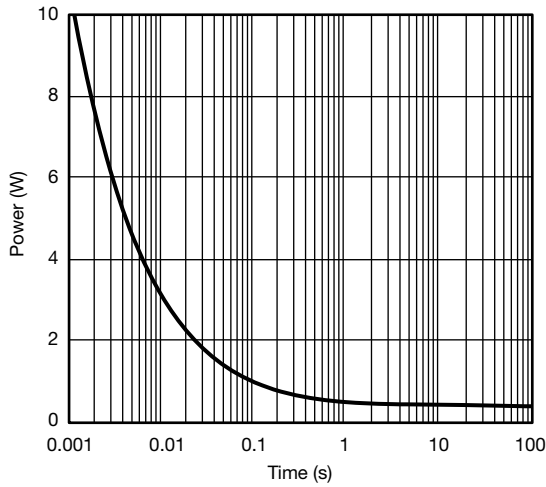

Single Pulse Power, Junction-to-Ambient

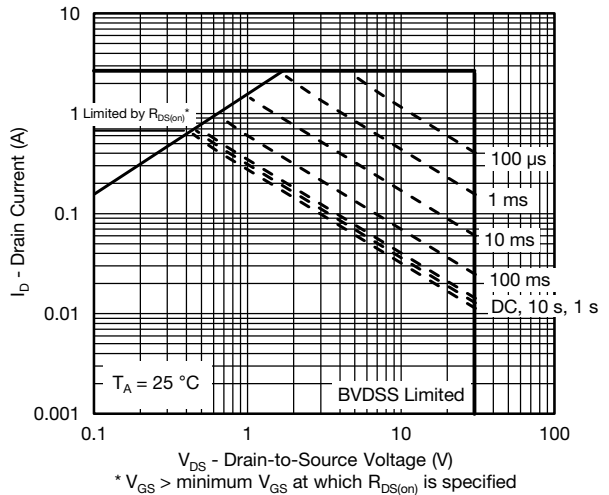

Safe Operating Area, Junction-to-Ambient

TYPICAL CHARACTERISTICS (25 °C, unless otherwise noted)

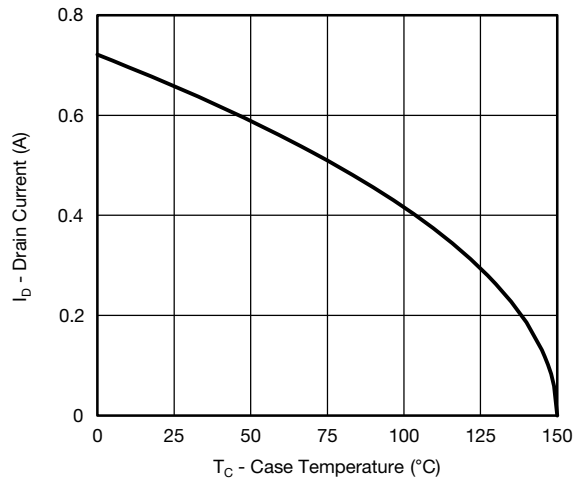

Current Derating*

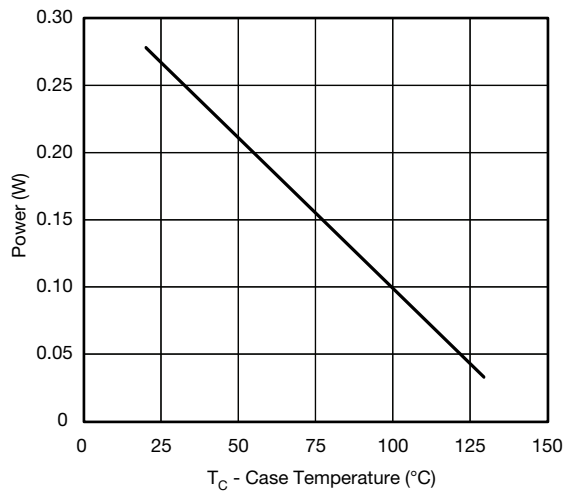

Power, Junction-to-Case

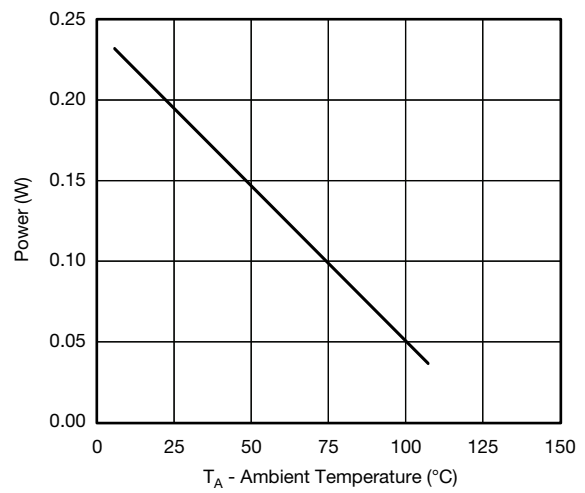

Power, Junction-to-Ambient

* The power dissipation P_D is based on $T_{J(max.)} = 150$ °C, using junction-to-case thermal resistance, and is more useful in settling the upper dissipation limit for cases where additional heatsinking is used. It is used to determine the current rating, when this rating falls below the package limit.

TYPICAL CHARACTERISTICS (25 °C, unless otherwise noted)

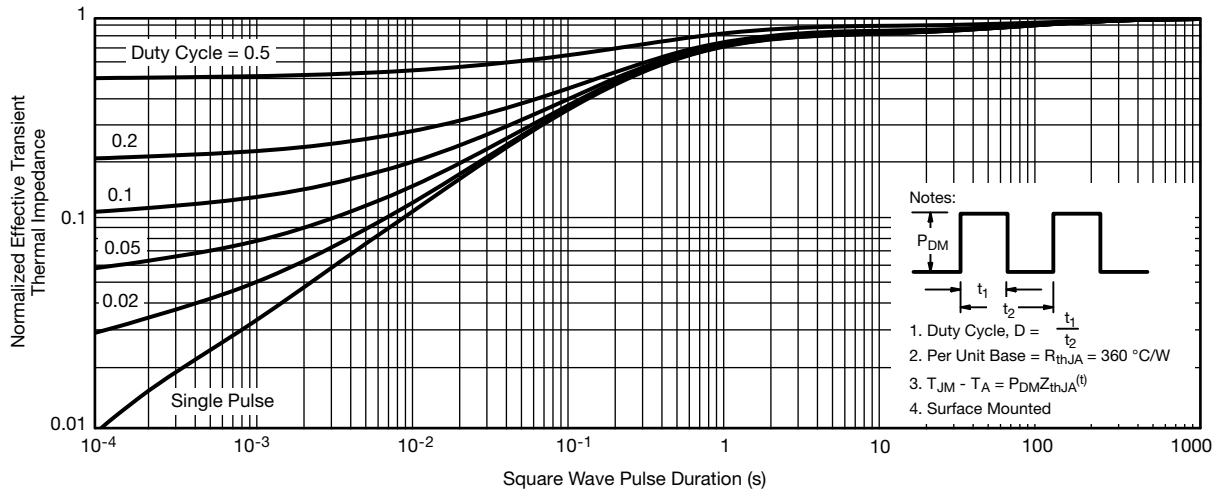

Normalized Thermal Transient Impedance, Junction-to-Ambient

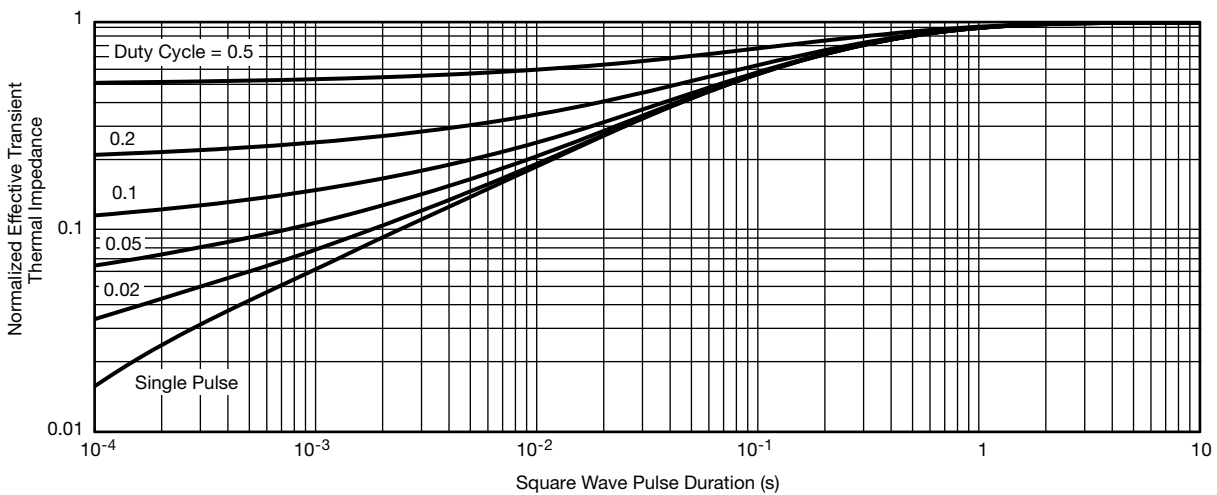

Normalized Thermal Transient Impedance, Junction-to-Foot

SOT-323

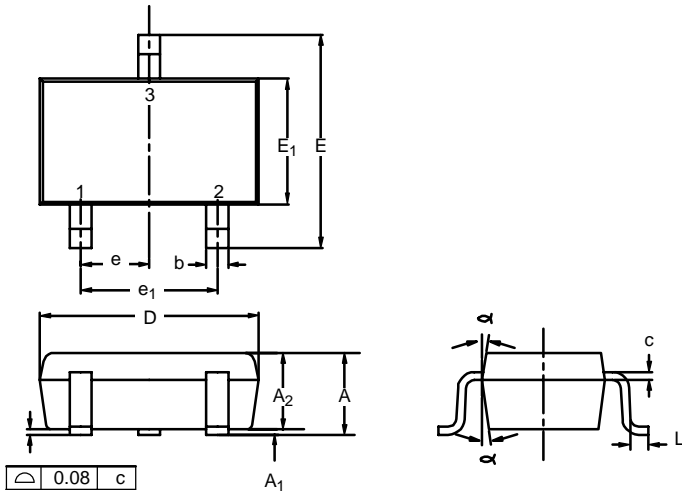

Dim	MILLIMETERS			INCHES		
	Min	Nom	Max	Min	Nom	Max
A	0.90	–	1.10	0.035	–	0.043
A₁	–	–	0.10	–	–	0.004
A₂	0.80	–	1.00	0.031	–	0.039
b	0.25	–	0.40	0.010	–	0.016
c	0.10	–	0.25	0.004	–	0.010
D	1.80	2.00	2.20	0.071	0.079	0.087
E	1.80	2.10	2.40	0.071	0.083	0.094
E₁	1.15	1.25	1.35	0.045	0.049	0.053
e	0.65BSC			0.026BSC		
e₁	1.20	1.30	1.40	0.047	0.051	0.055
L	0.10	0.20	0.30	0.004	0.008	0.012
α	7°Nom			7°Nom		

ECN: S-03946—Rev. C, 09-Jul-01
DWG: 5549

RECOMMENDED MINIMUM PADS FOR SOT-323



Recommended Minimum Pads
Dimensions in Inches/(mm)

Disclaimer

ALL PRODUCT, PRODUCT SPECIFICATIONS AND DATA ARE SUBJECT TO CHANGE WITHOUT NOTICE TO IMPROVE RELIABILITY, FUNCTION OR DESIGN OR OTHERWISE.

Din-Tek Intertechnology, Inc., its affiliates, agents, and employees, and all persons acting on its or their behalf (collectively, "Din-Tek"), disclaim any and all liability for any errors, inaccuracies or incompleteness contained in any datasheet or in any other disclosure relating to any product.

Din-Tek makes no warranty, representation or guarantee regarding the suitability of the products for any particular purpose or the continuing production of any product. To the maximum extent permitted by applicable law, Din-Tek disclaims (i) any and all liability arising out of the application or use of any product, (ii) any and all liability, including without limitation special, consequential or incidental damages, and (iii) any and all implied warranties, including warranties of fitness for particular purpose, non-infringement and merchantability.

Statements regarding the suitability of products for certain types of applications are based on Din-Tek's knowledge of typical requirements that are often placed on Din-Tek products in generic applications. Such statements are not binding statements about the suitability of products for a particular application. It is the customer's responsibility to validate that a particular product with the properties described in the product specification is suitable for use in a particular application. Parameters provided in datasheets and/or specifications may vary in different applications and performance may vary over time. All operating parameters, including typical parameters, must be validated for each customer application by the customer's technical experts. Product specifications do not expand or otherwise modify Din-Tek's terms and conditions of purchase, including but not limited to the warranty expressed therein.

Except as expressly indicated in writing, Din-Tek products are not designed for use in medical, life-saving, or life-sustaining applications or for any other application in which the failure of the Din-Tek product could result in personal injury or death. Customers using or selling Din-Tek products not expressly indicated for use in such applications do so at their own risk. Please contact authorized Din-Tek personnel to obtain written terms and conditions regarding products designed for such applications.

No license, express or implied, by estoppel or otherwise, to any intellectual property rights is granted by this document or by any conduct of Din-Tek. Product names and markings noted herein may be trademarks of their respective owners.

Material Category Policy

Din-Tek Intertechnology, Inc. hereby certifies that all its products that are identified as RoHS-Compliant fulfill the definitions and restrictions defined under Directive 2011/65/EU of The European Parliament and of the Council of June 8, 2011 on the restriction of the use of certain hazardous substances in electrical and electronic equipment (EEE) - recast, unless otherwise specified as non-compliant.

Please note that some Din-Tek documentation may still make reference to RoHS Directive 2002/95/EC. We confirm that all the products identified as being compliant to Directive 2002/95/EC conform to Directive 2011/65/EU.

Din-Tek Intertechnology, Inc. hereby certifies that all its products that are identified as Halogen-Free follow Halogen-Free requirements as per JEDEC JS709A standards. Please note that some Din-Tek documentation may still make reference to the IEC 61249-2-21 definition. We confirm that all the products identified as being compliant to IEC 61249-2-21 conform to JEDEC JS709A standards.