

## N-Channel 30 V (D-S) MOSFET

### PRODUCT SUMMARY

V <sub>DS</sub> (V)	R <sub>DS(on)</sub> (mΩ) TYP.	I <sub>D</sub> (A)	Q <sub>g</sub> (TYP.)
30	0.6 at V <sub>GS</sub> = 10 V	360	205 nC

### TOLL Pin Configuration

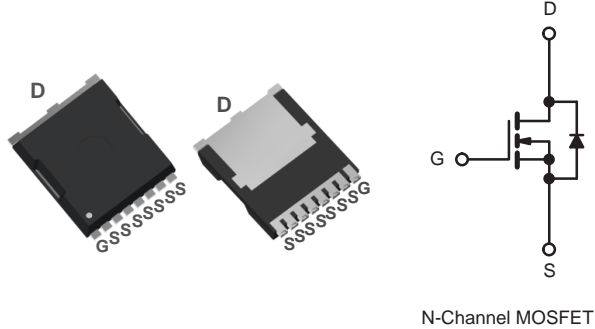

### FEATURES

- DT-Trench Power MOSFET
- 100 % R<sub>g</sub> and UIS tested

### APPLICATIONS

- Power supplies:
  - Uninterruptible power supplies
  - AC/DC switch-mode power supplies
  - Lighting
- Synchronous rectification
- DC/DC converter
- Motor drive switch
- DC/AC inverter
- Battery management



**RoHS**  
COMPLIANT  
HALOGEN  
**FREE**

### ABSOLUTE MAXIMUM RATINGS (T<sub>C</sub> = 25 °C, unless otherwise noted)

PARAMETER	SYMBOL	LIMIT	UNIT
Drain-Source Voltage	V <sub>DS</sub>	30	V
Gate-Source Voltage	V <sub>GS</sub>	± 20	
Continuous Drain Current (T <sub>J</sub> = 150 °C)	I <sub>D</sub>	T <sub>C</sub> = 25 °C	360
		T <sub>C</sub> = 100 °C	255
Pulsed Drain Current (t = 100 μs)	I <sub>DM</sub>	1440	A
Avalanche Current <sup>d</sup>	I <sub>AS</sub>	125	mJ
Single Avalanche Energy <sup>a</sup>	E <sub>AS</sub>	1258	
Maximum Power Dissipation <sup>a</sup>	P <sub>D</sub>	T <sub>C</sub> = 25 °C	310 <sup>b</sup>
		T <sub>C</sub> = 100 °C	156 <sup>b</sup>
Operating Junction and Storage Temperature Range	T <sub>J</sub> , T <sub>stg</sub>	-55 to +175	°C

### THERMAL RESISTANCE RATINGS

PARAMETER	SYMBOL	LIMIT	UNIT
Junction-to-Ambient (PCB Mount) <sup>c</sup>	R <sub>thJA</sub>	15	°C/W
Junction-to-Case (Drain)	R <sub>thJC</sub>	0.5	

### Notes

- Duty cycle ≤ 1 %.
- See SOA curve for voltage derating.
- When mounted on 1" square PCB (FR4 material).
- Single pulse width limited by junction temperature T<sub>J</sub>(MAX)=150°C.

<b>SPECIFICATIONS</b> ( $T_J = 25\text{ }^\circ\text{C}$ , unless otherwise noted)						
PARAMETER	SYMBOL	TEST CONDITIONS	MIN.	TYP.	MAX.	UNIT
<b>Static</b>						
Drain-Source Breakdown Voltage	$V_{DS}$	$V_{GS} = 0\text{ V}, I_D = 250\text{ }\mu\text{A}$	30	-	-	V
Gate Threshold Voltage	$V_{GS(th)}$	$V_{DS} = V_{GS}, I_D = 250\text{ }\mu\text{A}$	1	-	3	
Gate-Body Leakage	$I_{GSS}$	$V_{DS} = 0\text{ V}, V_{GS} = \pm 20\text{ V}$	-	-	$\pm 100$	nA
Zero Gate Voltage Drain Current	$I_{DSS}$	$V_{DS} = 30\text{ V}, V_{GS} = 0\text{ V}$	-	-	1	$\mu\text{A}$
		$V_{DS} = 24\text{ V}, V_{GS} = 0\text{ V}, T_J = 85\text{ }^\circ\text{C}$	-	-	10	
On-State Drain Current <sup>a</sup>	$I_{D(on)}$	$V_{DS} \geq 10\text{ V}, V_{GS} = 10\text{ V}$	360	-	-	A
Drain-Source On-State Resistance <sup>a</sup>	$R_{DS(on)}$	$V_{GS} = 10\text{ V}, I_D = 50\text{ A}$	-	0.6	0.8	m $\Omega$
		$V_{GS} = 4.5\text{ V}, I_D = 50\text{ A}$	-	0.98	1.3	
Forward Transconductance <sup>a</sup>	$g_{fs}$	$V_{DS} = 10\text{ V}, I_D = 50\text{ A}$	-	123	-	S
<b>Dynamic <sup>b</sup></b>						
Input Capacitance	$C_{iss}$	$V_{GS} = 0\text{ V}, V_{DS} = 15\text{ V}, f = 1\text{ MHz}$	-	14500	-	pF
Output Capacitance	$C_{oss}$		-	2680	-	
Reverse Transfer Capacitance	$C_{rss}$		-	778	-	
Total Gate Charge <sup>c</sup>	$Q_g$	$V_{DS} = 15\text{ V}, V_{GS} = 10\text{ V}, I_D = 50\text{ A}$	-	205	-	nC
Gate-Source Charge <sup>c</sup>	$Q_{gs}$		-	43	-	
Gate-Drain Charge <sup>c</sup>	$Q_{gd}$		-	37	-	
Gate Resistance	$R_g$	$f = 1\text{ MHz}$	-	2.8	-	$\Omega$
Turn-On Delay Time <sup>c</sup>	$t_{d(on)}$	$V_{DD} = 15\text{ V}, I_D = 50\text{ A}, R_g = 3\text{ }\Omega$ $V_{GEN} = 10\text{ V}$	-	49	-	ns
Rise Time <sup>c</sup>	$t_r$		-	56	-	
Turn-Off Delay Time <sup>c</sup>	$t_{d(off)}$		-	166	-	
Fall Time <sup>c</sup>	$t_f$		-	72	-	
<b>Drain-Source Body Diode Ratings and Characteristics <sup>b</sup></b> ( $T_C = 25\text{ }^\circ\text{C}$ )						
Continuous Source-Drain Diode Current	$I_S$	$T_C = 25\text{ }^\circ\text{C}$	-	-	360	A
Pulsed Current ( $t = 100\text{ }\mu\text{s}$ )	$I_{SM}$		-	-	1440	A
Forward Voltage <sup>a</sup>	$V_{SD}$	$I_F = 1\text{ A}, V_{GS} = 0\text{ V}$	-	-	1	V
Reverse Recovery Time	$t_{rr}$	$I_F = 50\text{ A}, di/dt = 500\text{ A}/\mu\text{s}$	-	58	-	ns
Reverse Recovery Charge	$Q_{rr}$		-	185	-	nC

**Notes**

- Pulse test; pulse width  $\leq 300\text{ }\mu\text{s}$ , duty cycle  $\leq 2\%$ .
- Guaranteed by design, not subject to production testing.
- Independent of operating temperature.

Stresses beyond those listed under "Absolute Maximum Ratings" may cause permanent damage to the device. These are stress ratings only, and functional operation of the device at these or any other conditions beyond those indicated in the operational sections of the specifications is not implied. Exposure to absolute maximum rating conditions for extended periods may affect device reliability.

**TYPICAL CHARACTERISTICS** ( $T_A = 25\text{ }^\circ\text{C}$ , unless otherwise noted)

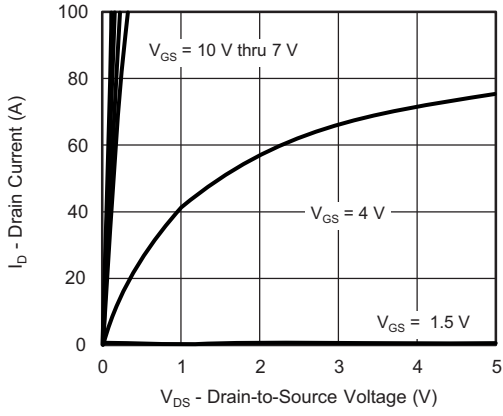

**Output Characteristics**

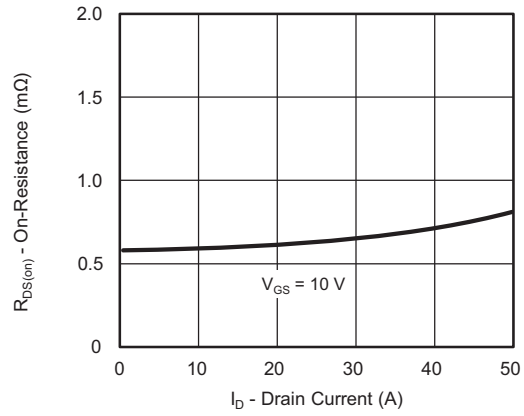

**On-Resistance vs. Drain Current**

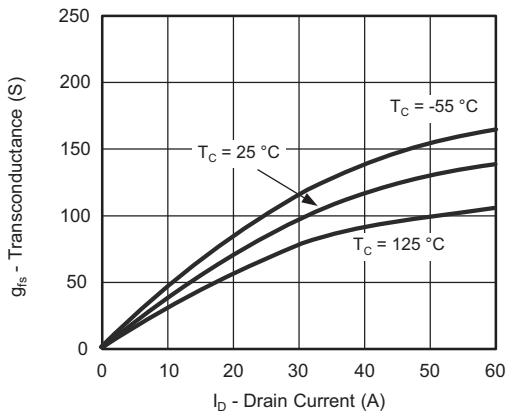

**Transconductance**

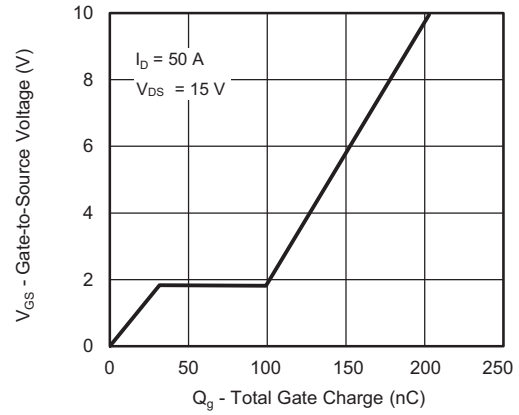

**Gate Charge**

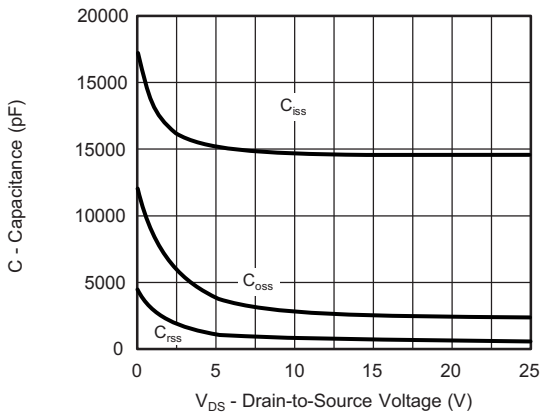

**Capacitance**

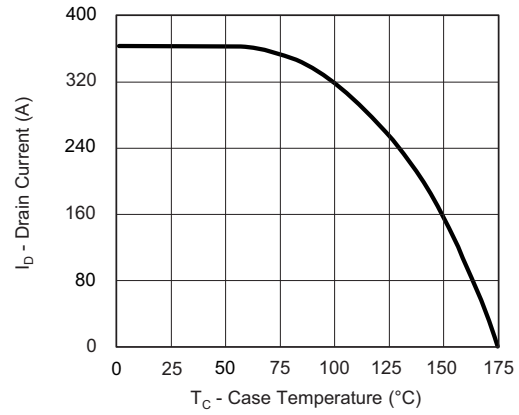

**Current De-Rating**

**TYPICAL CHARACTERISTICS** ( $T_A = 25\text{ }^\circ\text{C}$ , unless otherwise noted)

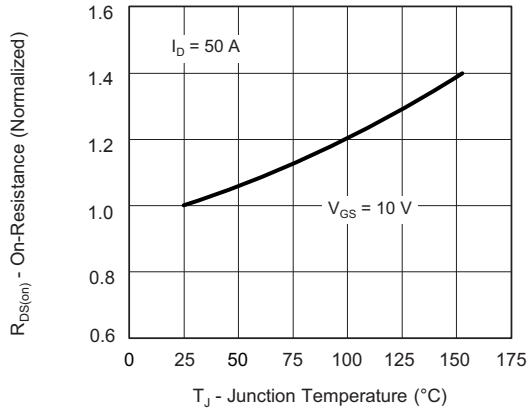

**On-Resistance vs. Junction Temperature**

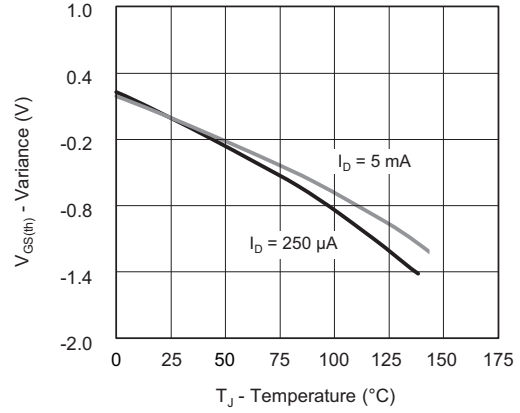

**Threshold Voltage**

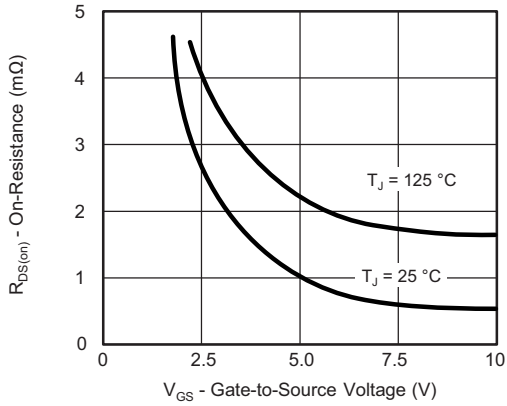

**On-Resistance vs. Gate-to-Source Voltage**

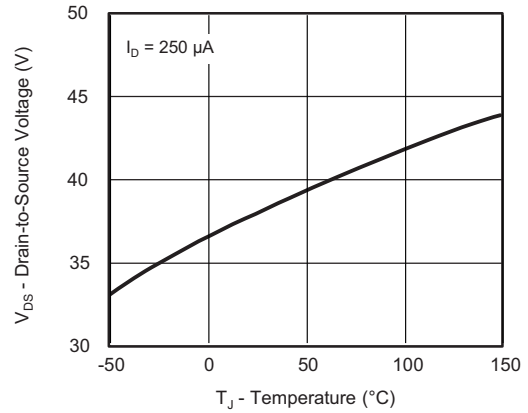

**Drain Source Breakdown vs. Junction Temperature**

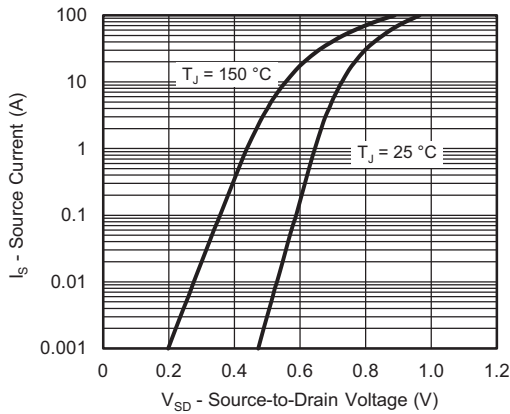

**Source Drain Diode Forward Voltage**

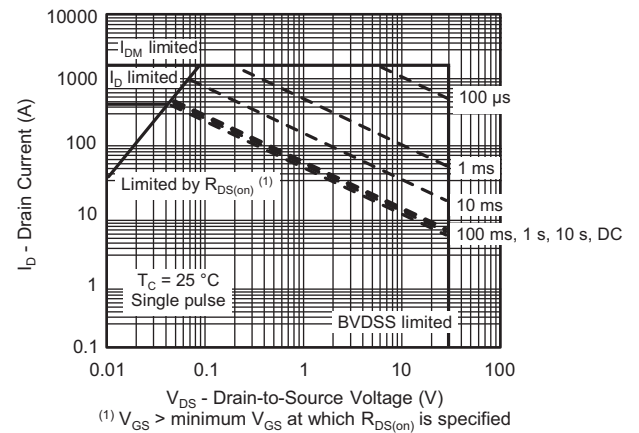

**Safe Operating Area**

(1)  $V_{GS} >$  minimum  $V_{GS}$  at which  $R_{DS(on)}$  is specified

**THERMAL RATINGS** ( $T_A = 25\text{ }^\circ\text{C}$ , unless otherwise noted)

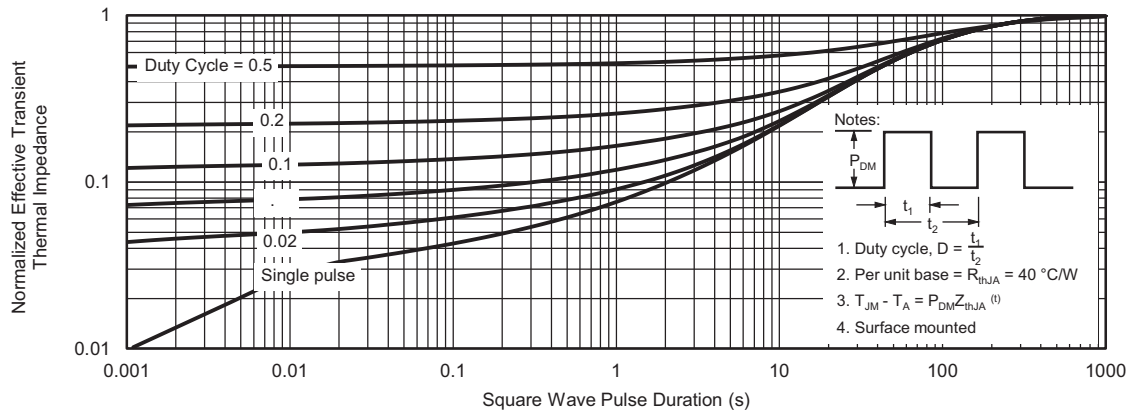

**Normalized Thermal Transient Impedance, Junction-to-Ambient**

## TOLL PACKAGE INFORMATION

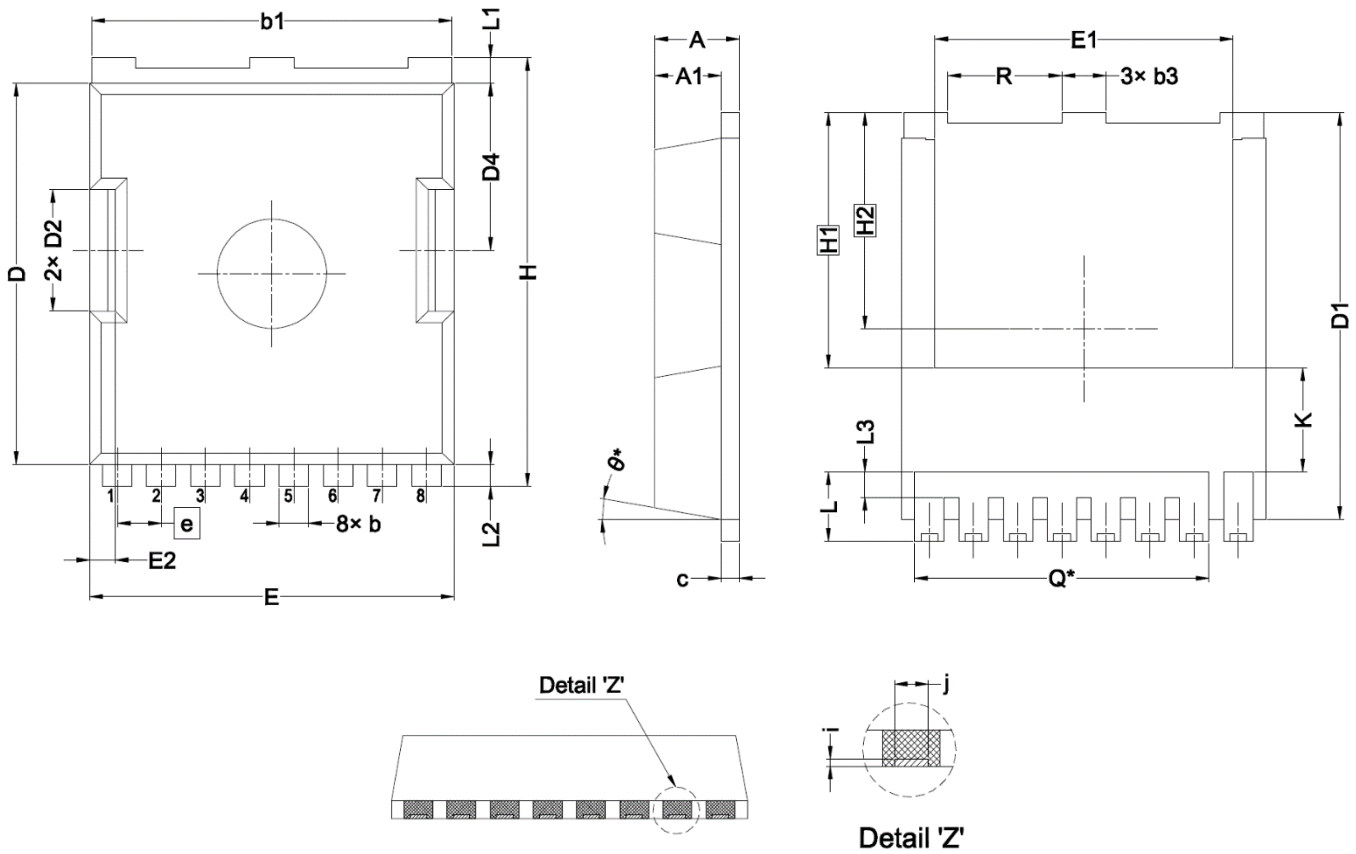

SYMBOL	mm			SYMBOL	mm		
	MIN	NOM	MAX		MIN	NOM	MAX
A	2.20	2.30	2.40	H	11.58	11.68	11.78
A1	1.70	1.80	1.90	H1	6.95 BSC		
b	0.70	0.80	0.90	H2	5.89 BSC		
b1	9.70	9.80	9.90	i	0.10 REF		
b3	1.10	1.20	1.30	j	0.46 REF		
c	0.40	0.50	0.60	K	2.80 REF		
D	10.28	10.38	10.48	L	1.40	1.90	2.10
D1	10.98	11.08	11.18	L1	0.60	0.70	0.80
D2	3.20	3.30	3.40	L2	0.50	0.60	0.70
D4	4.45	4.55	4.65	L3	0.30	0.70	0.80
E	9.80	9.90	10.00	N	8		
E1	8.00	8.10	8.20	Q	8.00 REF		
E2	0.60	0.70	0.80	R	3.00	3.10	3.20
e	1.20 BSC			$\theta$	10° REF		

## TOLL RECOMMENDED LAND PATTERN

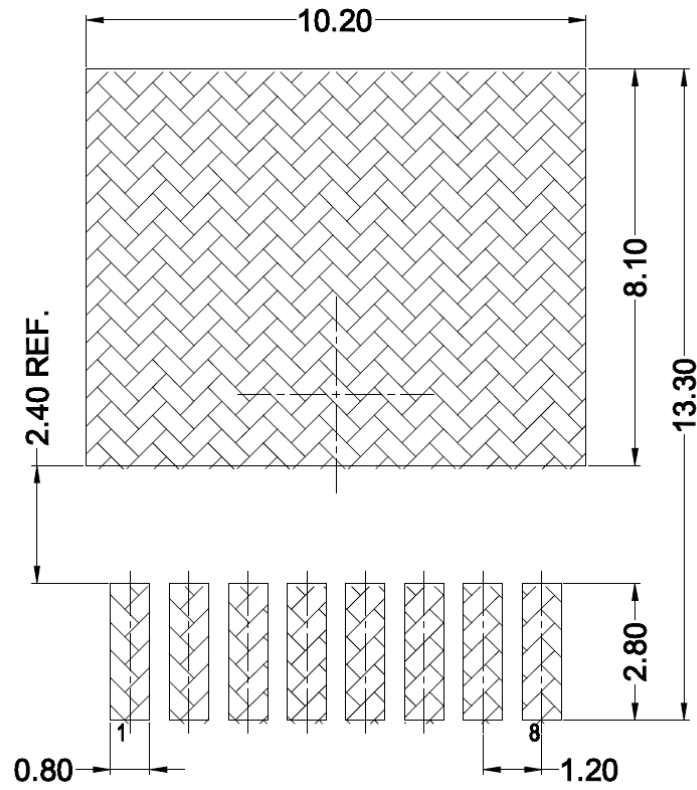

unit : mm

## Disclaimer

ALL PRODUCT, PRODUCT SPECIFICATIONS AND DATA ARE SUBJECT TO CHANGE WITHOUT NOTICE TO IMPROVE RELIABILITY, FUNCTION OR DESIGN OR OTHERWISE.

Din-Tek Intertechnology, Inc., its affiliates, agents, and employees, and all persons acting on its or their behalf (collectively, "Din-Tek"), disclaim any and all liability for any errors, inaccuracies or incompleteness contained in any datasheet or in any other disclosure relating to any product.

Din-Tek makes no warranty, representation or guarantee regarding the suitability of the products for any particular purpose or the continuing production of any product. To the maximum extent permitted by applicable law, Din-Tek disclaims (i) any and all liability arising out of the application or use of any product, (ii) any and all liability, including without limitation special, consequential or incidental damages, and (iii) any and all implied warranties, including warranties of fitness for particular purpose, non-infringement and merchantability.

Statements regarding the suitability of products for certain types of applications are based on Din-Tek's knowledge of typical requirements that are often placed on Din-Tek products in generic applications. Such statements are not binding statements about the suitability of products for a particular application. It is the customer's responsibility to validate that a particular product with the properties described in the product specification is suitable for use in a particular application. Parameters provided in datasheets and/or specifications may vary in different applications and performance may vary over time. All operating parameters, including typical parameters, must be validated for each customer application by the customer's technical experts. Product specifications do not expand or otherwise modify Din-Tek's terms and conditions of purchase, including but not limited to the warranty expressed therein.

Except as expressly indicated in writing, Din-Tek products are not designed for use in medical, life-saving, or life-sustaining applications or for any other application in which the failure of the Din-Tek product could result in personal injury or death. Customers using or selling Din-Tek products not expressly indicated for use in such applications do so at their own risk. Please contact authorized Din-Tek personnel to obtain written terms and conditions regarding products designed for such applications.

No license, express or implied, by estoppel or otherwise, to any intellectual property rights is granted by this document or by any conduct of Din-Tek. Product names and markings noted herein may be trademarks of their respective owners.

## Material Category Policy

**Din-Tek Intertechnology, Inc. hereby certifies that all its products that are identified as RoHS-Compliant fulfill the definitions and restrictions defined under Directive 2011/65/EU of The European Parliament and of the Council of June 8, 2011 on the restriction of the use of certain hazardous substances in electrical and electronic equipment (EEE) - recast, unless otherwise specified as non-compliant.**

**Please note that some Din-Tek documentation may still make reference to RoHS Directive 2002/95/EC. We confirm that all the products identified as being compliant to Directive 2002/95/EC conform to Directive 2011/65/EU.**

**Din-Tek Intertechnology, Inc. hereby certifies that all its products that are identified as Halogen-Free follow Halogen-Free requirements as per JEDEC JS709A standards. Please note that some Din-Tek documentation may still make reference to the IEC 61249-2-21 definition. We confirm that all the products identified as being compliant to IEC 61249-2-21 conform to JEDEC JS709A standards.**