

N-Channel 30-V (D-S) MOSFET

PRODUCT SUMMARY			
V _{DS} (V)	R _{DS(on)} (Ω)	I _D (A) ^a	Q _g (Typ.)
30	0.020 at V _{GS} = 10 V	6.8	10 nC
	0.022 at V _{GS} = 4.5 V	4.8	

FEATURES

- DT-Trench Power MOSFET

APPLICATIONS

- Load Switches for Portable Devices



RoHS
COMPLIANT

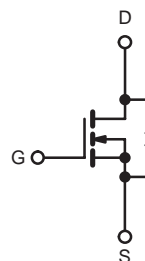
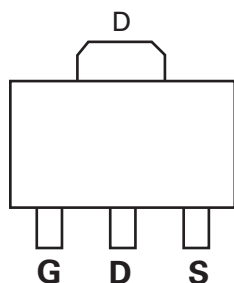

N-Channel MOSFET

ABSOLUTE MAXIMUM RATINGS T _A = 25 °C, unless otherwise noted				
Parameter	Symbol	Limit	Unit	
Drain-Source Voltage	V _{DS}	30	V	
Gate-Source Voltage	V _{GS}	± 20	V	
Continuous Drain Current (T _J = 150 °C)	I _D	T _C = 25 °C	6.8 ^a	A
		T _C = 70 °C	6 ^a	
		T _A = 25 °C	6.8 ^{a, b, c}	
		T _A = 70 °C	6 ^{a, b, c}	
Pulsed Drain Current	I _{DM}	30	A	
Continuous Source-Drain Diode Current	I _S	T _C = 25 °C	5.2	A
		T _A = 25 °C	2.1 ^{b, c}	
Maximum Power Dissipation	P _D	T _C = 25 °C	6.3	W
		T _C = 70 °C	4	
		T _A = 25 °C	2.5 ^{b, c}	
		T _A = 70 °C	1.6 ^{b, c}	
Operating Junction and Storage Temperature Range	T _J , T _{stg}	- 55 to 150	°C	
Soldering Recommendations (Peak Temperature) ^{e, f}		260	°C	

THERMAL RESISTANCE RATINGS					
Parameter	Symbol	Typical	Maximum	Unit	
Maximum Junction-to-Ambient ^{a, c, d}	R _{thJA}	40	50	°C/W	
Maximum Junction-to-Foot (Drain)	R _{thJF}	15	20	°C/W	

Notes:

a. Package limited, T_C = 25 °C.

b. Surface Mounted on 1" x 1" FR4 board.

c. t = 10 s.

d. Maximum under Steady State conditions is 95 °C/W.

e. See Reliability Manual for profile. The ChipFET is a leadless package. The end of the lead terminal is exposed copper (not plated) as a result of the singulation process in manufacturing. A solder fillet at the exposed copper tip cannot be guaranteed and is not required to ensure adequate bottom side solder interconnection.

f. Rework Conditions: manual soldering with a soldering iron is not recommended for leadless components.

SPECIFICATIONS $T_J = 25\text{ }^\circ\text{C}$, unless otherwise noted						
Parameter	Symbol	Test Conditions	Min.	Typ.	Max.	Unit
Static						
Drain-Source Breakdown Voltage	V_{DS}	$V_{GS} = 0\text{ V}, I_D = 250\text{ }\mu\text{A}$	30			V
V_{DS} Temperature Coefficient	$\Delta V_{DS}/T_J$	$I_D = 250\text{ }\mu\text{A}$		25		mV/ $^\circ\text{C}$
$V_{GS(th)}$ Temperature Coefficient	$\Delta V_{GS(th)}/T_J$			-4.0		
Gate-Source Threshold Voltage	$V_{GS(th)}$	$V_{DS} = V_{GS}, I_D = 250\text{ }\mu\text{A}$	0.6		1.5	V
Gate-Source Leakage	I_{GSS}	$V_{DS} = 0\text{ V}, V_{GS} = \pm 20\text{ V}$			± 100	nA
Zero Gate Voltage Drain Current	I_{DSS}	$V_{DS} = 30\text{ V}, V_{GS} = 0\text{ V}$			1	μA
		$V_{DS} = 30\text{ V}, V_{GS} = 0\text{ V}, T_J = 55\text{ }^\circ\text{C}$			10	
On-State Drain Current ^a	$I_{D(on)}$	$V_{DS} \geq 5\text{ V}, V_{GS} = 4.5\text{ V}$	30			A
Drain-Source On-State Resistance ^a	$R_{DS(on)}$	$V_{GS} = 10\text{ V}, I_D = 6.3\text{ A}$		0.020	0.025	Ω
		$V_{GS} = 4.5\text{ V}, I_D = 4.5\text{ A}$		0.022	0.028	
Forward Transconductance ^a	g_{fs}	$V_{DS} = 10\text{ V}, I_D = 6.3\text{ A}$		45		S
Dynamic^b						
Input Capacitance	C_{iss}	$V_{DS} = 10\text{ V}, V_{GS} = 0\text{ V}, f = 1\text{ MHz}$		1200		pF
Output Capacitance	C_{oss}			220		
Reverse Transfer Capacitance	C_{rss}			100		
Total Gate Charge	Q_g	$V_{DS} = 10\text{ V}, V_{GS} = 10\text{ V}, I_D = 6.3\text{ A}$		22	33	nC
				10	15	
Gate-Source Charge	Q_{gs}	$V_{DS} = 10\text{ V}, V_{GS} = 4.5\text{ V}, I_D = 6.3\text{ A}$		2.5		
Gate-Drain Charge	Q_{gd}			1.7		
Gate Resistance	R_g	$f = 1\text{ MHz}$		2.4		Ω
Turn-on Delay Time	$t_{d(on)}$	$V_{DD} = 10\text{ V}, R_L = 1.5\text{ }\Omega$ $I_D \cong 6.7\text{ A}, V_{GEN} = 4.5\text{ V}, R_g = 1\text{ }\Omega$		15	25	ns
Rise Time	t_r			10	15	
Turn-Off Delay Time	$t_{d(off)}$			35	55	
Fall Time	t_f			12	20	
Turn-on Delay Time	$t_{d(on)}$	$V_{DD} = 10\text{ V}, R_L = 1.5\text{ }\Omega$ $I_D \cong 6.7\text{ A}, V_{GEN} = 10\text{ V}, R_g = 1\text{ }\Omega$		10	15	
Rise Time	t_r			12	20	
Turn-Off Delay Time	$t_{d(off)}$			25	40	
Fall Time	t_f			10	15	
Drain-Source Body Diode Characteristics						
Continuous Source-Drain Diode Current	I_S	$T_C = 25\text{ }^\circ\text{C}$			5.2	A
Pulse Diode Forward Current	I_{SM}				30	
Body Diode Voltage	V_{SD}	$I_S = 6.7\text{ A}, V_{GS} = 0\text{ V}$		0.8	1.2	V
Body Diode Reverse Recovery Time	t_{rr}	$I_F = 6.7\text{ A}, dI/dt = 100\text{ A}/\mu\text{s}, T_J = 25\text{ }^\circ\text{C}$		20	40	ns
Body Diode Reverse Recovery Charge	Q_{rr}			10	20	nC
Reverse Recovery Fall Time	t_a			10		ns
Reverse Recovery Rise Time	t_b			10		

Notes:

- a. Pulse test; pulse width $\leq 300\text{ }\mu\text{s}$, duty cycle $\leq 2\%$
 b. Guaranteed by design, not subject to production testing.

Stresses beyond those listed under "Absolute Maximum Ratings" may cause permanent damage to the device. These are stress ratings only, and functional operation of the device at these or any other conditions beyond those indicated in the operational sections of the specifications is not implied. Exposure to absolute maximum rating conditions for extended periods may affect device reliability.

TYPICAL CHARACTERISTICS 25 °C, unless otherwise noted

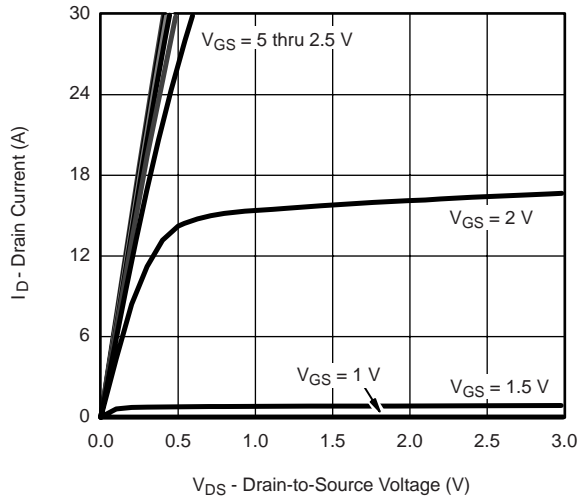

V_{DS} - Drain-to-Source Voltage (V)
Output Characteristics



V_{GS} - Gate-to-Source Voltage (V)
Transfer Characteristics

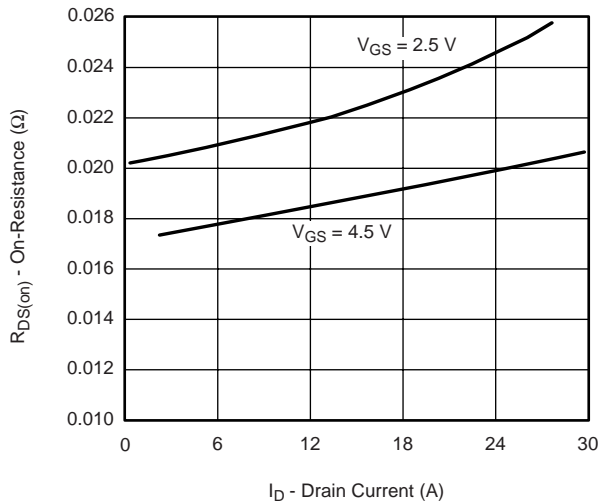

I_D - Drain Current (A)
On-Resistance vs. Drain Current



V_{DS} - Drain-to-Source Voltage (V)
Capacitance

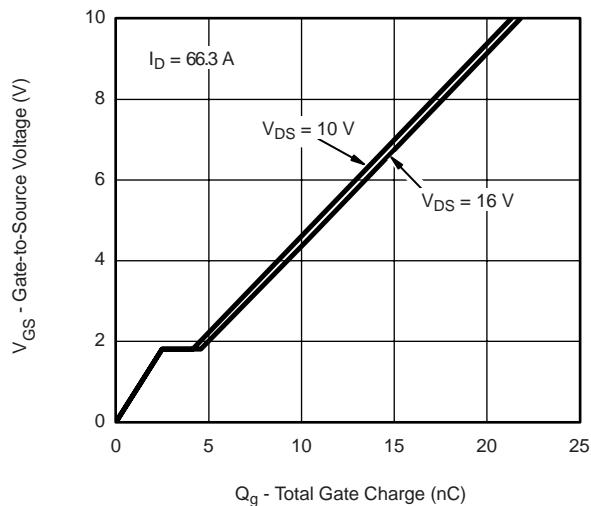

Q_g - Total Gate Charge (nC)
Gate Charge

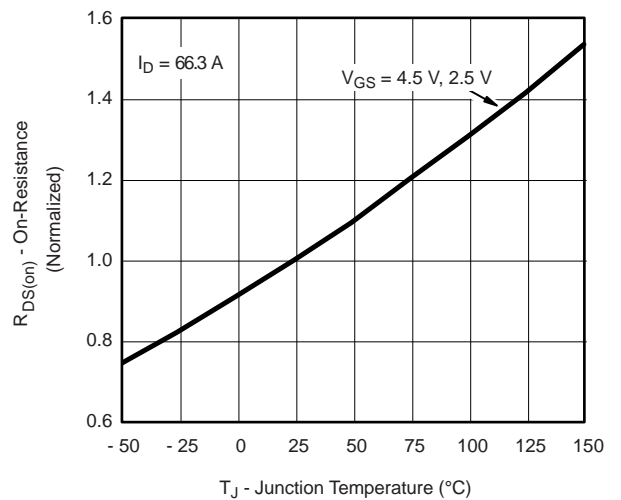

T_J - Junction Temperature ($^\circ\text{C}$)
On-Resistance vs. Junction Temperature

TYPICAL CHARACTERISTICS 25 °C, unless otherwise noted

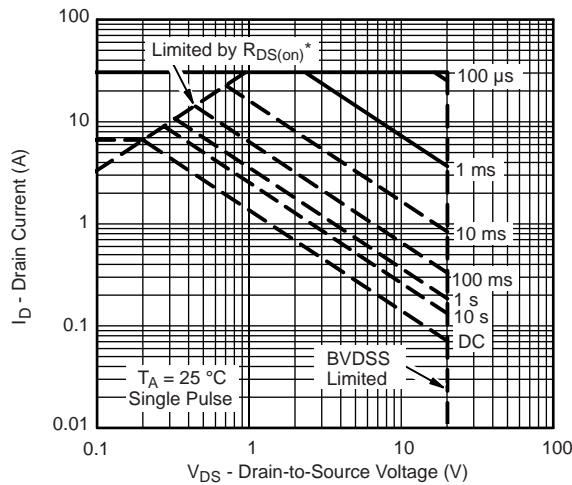
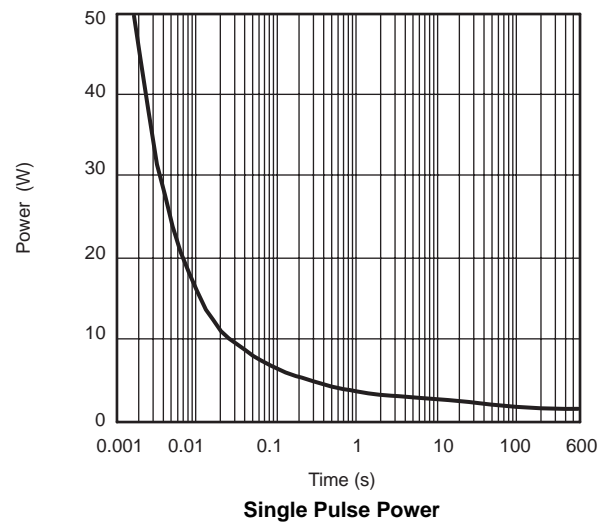
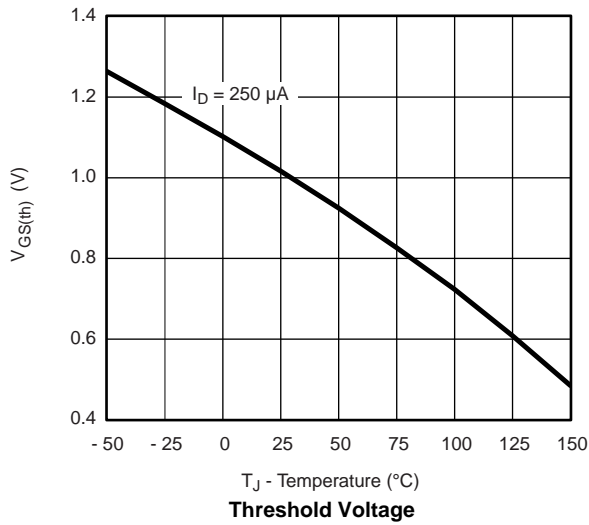
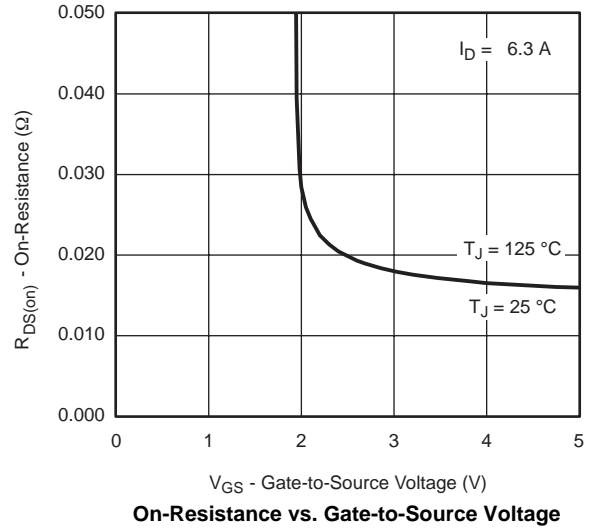
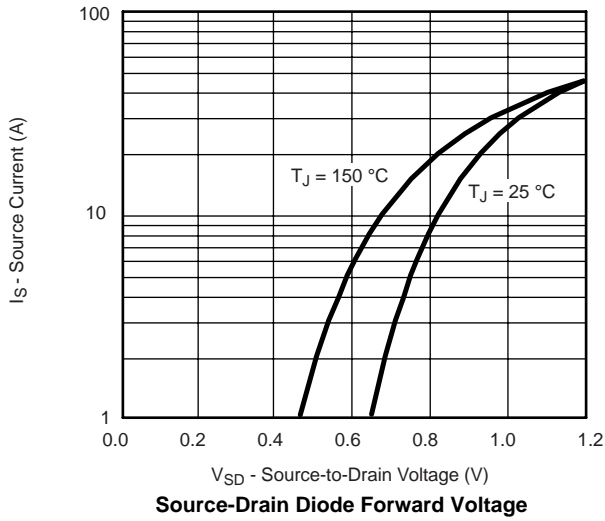

* $V_{GS} >$ minimum V_{GS} at which $R_{DS(on)}$ is specified

TYPICAL CHARACTERISTICS 25 °C, unless otherwise noted

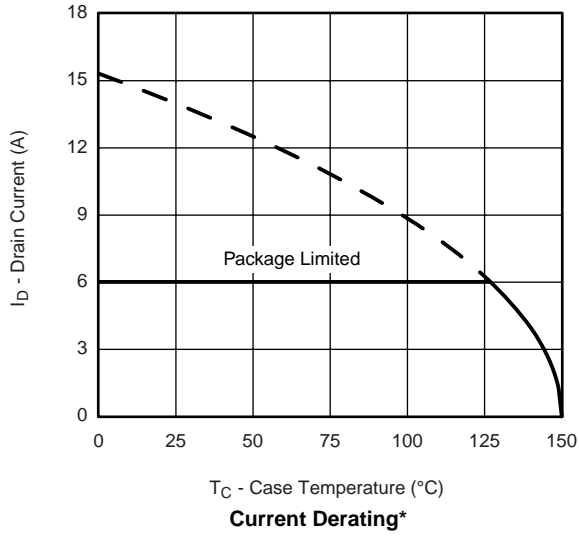

* The power dissipation P_D is based on $T_{J(max)} = 150$ °C, using junction-to-case thermal resistance, and is more useful in settling the upper dissipation limit for cases where additional heatsinking is used. It is used to determine the current rating, when this rating falls below the package limit.

TYPICAL CHARACTERISTICS 25 °C, unless otherwise noted

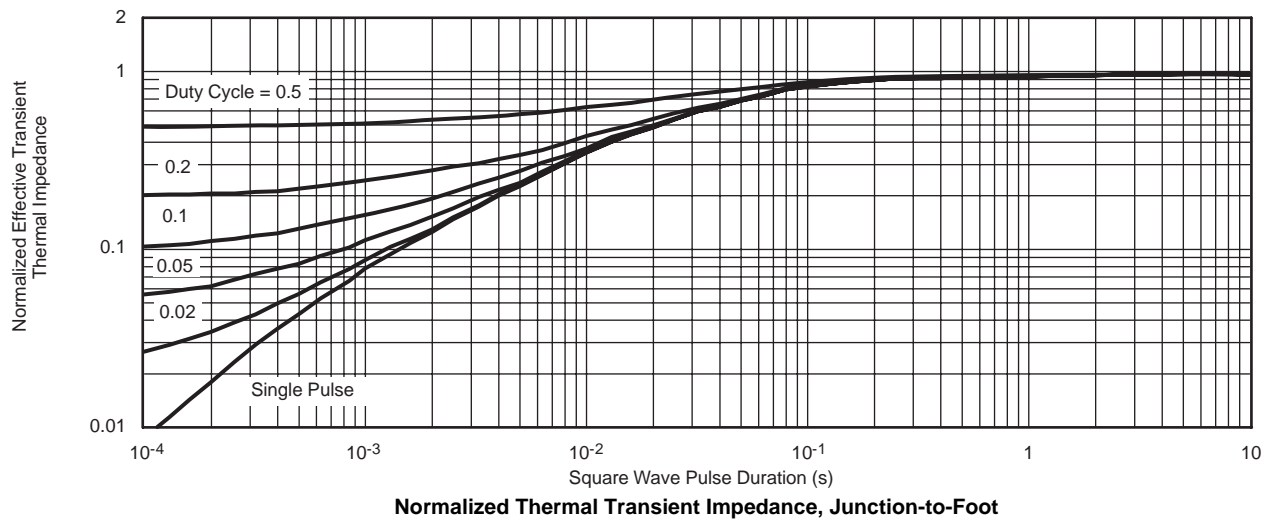
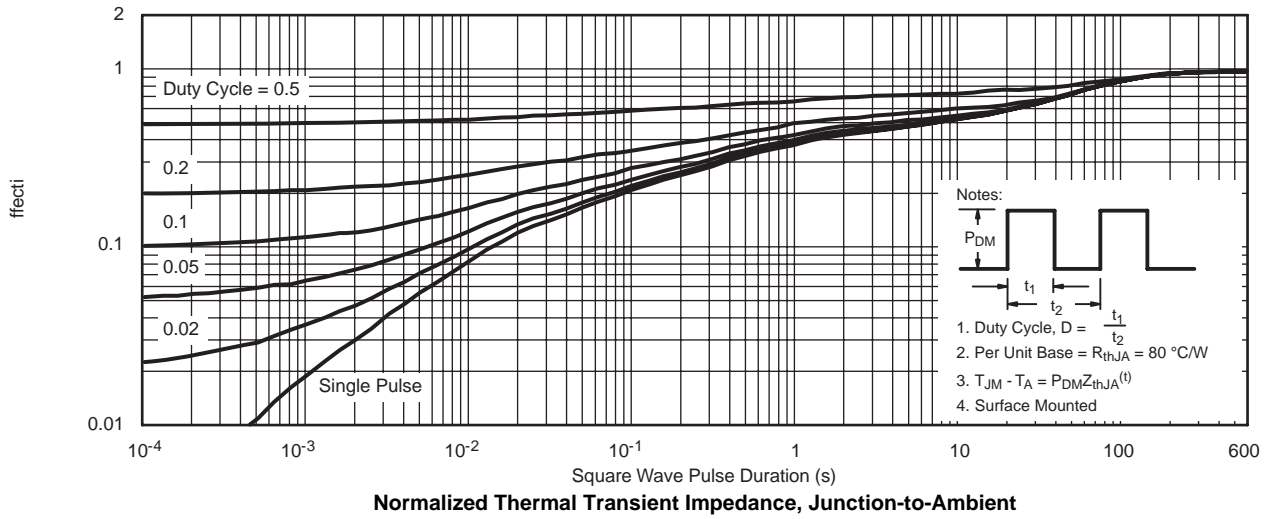

Package outline - SOT89

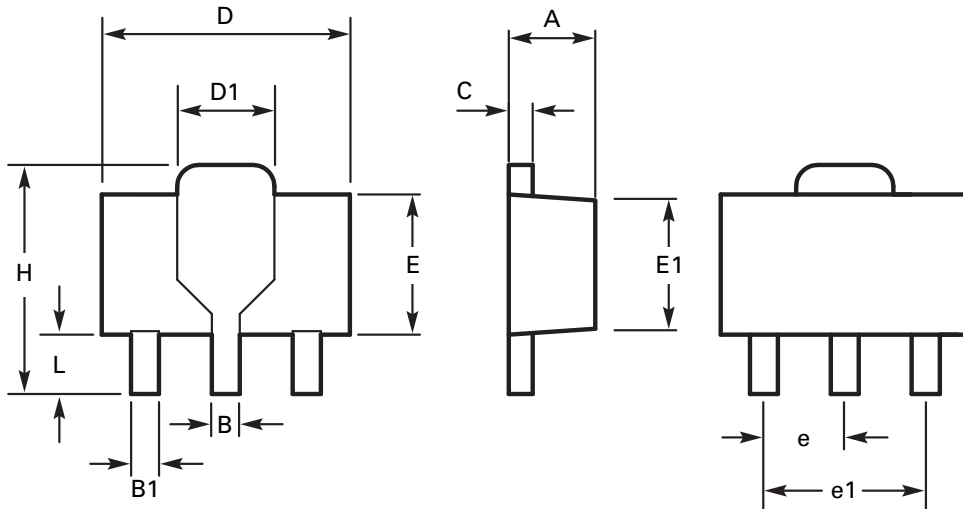

DIM	Millimeters		Inches		DIM	Millimeters		Inches	
	Min	Max	Min	Max		Min	Max	Min	Max
A	1.40	1.60	0.550	0.630	E	2.29	2.60	0.090	0.102
B	0.44	0.56	0.017	0.022	E1	2.13	2.29	0.084	0.090
B1	0.36	0.48	0.014	0.019	e	1.50 BSC		0.059 BSC	
C	0.35	0.44	0.014	0.017	e1	3.00 BSC		0.118 BSC	
D	4.40	4.60	0.173	0.181	H	3.94	4.25	0.155	0.167
D1	1.62	1.83	0.064	0.072	L	0.89	1.20	0.035	0.047

Note: Controlling dimensions are in millimeters. Approximate dimensions are provided in inches

Disclaimer

ALL PRODUCT, PRODUCT SPECIFICATIONS AND DATA ARE SUBJECT TO CHANGE WITHOUT NOTICE TO IMPROVE RELIABILITY, FUNCTION OR DESIGN OR OTHERWISE.

Din-Tek Intertechnology, Inc., its affiliates, agents, and employees, and all persons acting on its or their behalf (collectively, "Din-Tek"), disclaim any and all liability for any errors, inaccuracies or incompleteness contained in any datasheet or in any other disclosure relating to any product.

Din-Tek makes no warranty, representation or guarantee regarding the suitability of the products for any particular purpose or the continuing production of any product. To the maximum extent permitted by applicable law, Din-Tek disclaims (i) any and all liability arising out of the application or use of any product, (ii) any and all liability, including without limitation special, consequential or incidental damages, and (iii) any and all implied warranties, including warranties of fitness for particular purpose, non-infringement and merchantability.

Statements regarding the suitability of products for certain types of applications are based on Din-Tek's knowledge of typical requirements that are often placed on Din-Tek products in generic applications. Such statements are not binding statements about the suitability of products for a particular application. It is the customer's responsibility to validate that a particular product with the properties described in the product specification is suitable for use in a particular application. Parameters provided in datasheets and/or specifications may vary in different applications and performance may vary over time. All operating parameters, including typical parameters, must be validated for each customer application by the customer's technical experts. Product specifications do not expand or otherwise modify Din-Tek's terms and conditions of purchase, including but not limited to the warranty expressed therein.

Except as expressly indicated in writing, Din-Tek products are not designed for use in medical, life-saving, or life-sustaining applications or for any other application in which the failure of the Din-Tek product could result in personal injury or death. Customers using or selling Din-Tek products not expressly indicated for use in such applications do so at their own risk. Please contact authorized Din-Tek personnel to obtain written terms and conditions regarding products designed for such applications.

No license, express or implied, by estoppel or otherwise, to any intellectual property rights is granted by this document or by any conduct of Din-Tek. Product names and markings noted herein may be trademarks of their respective owners.

Material Category Policy

Din-Tek Intertechnology, Inc. hereby certifies that all its products that are identified as RoHS-Compliant fulfill the definitions and restrictions defined under Directive 2011/65/EU of The European Parliament and of the Council of June 8, 2011 on the restriction of the use of certain hazardous substances in electrical and electronic equipment (EEE) - recast, unless otherwise specified as non-compliant.

Please note that some Din-Tek documentation may still make reference to RoHS Directive 2002/95/EC. We confirm that all the products identified as being compliant to Directive 2002/95/EC conform to Directive 2011/65/EU.

Din-Tek Intertechnology, Inc. hereby certifies that all its products that are identified as Halogen-Free follow Halogen-Free requirements as per JEDEC JS709A standards. Please note that some Din-Tek documentation may still make reference to the IEC 61249-2-21 definition. We confirm that all the products identified as being compliant to IEC 61249-2-21 conform to JEDEC JS709A standards.