

650V N-Channel Silicon Carbide Power MOSFET

Features

- High blocking voltage with low on-resistance
- High speed switching with low capacitance
- High operating junction temperature capability
- Very fast and robust intrinsic body diode

Applications

- EV chargers
- Server & Telecom PSU
- Solar inverters
- UPS
- High voltage DC/DC converters
- Switch mode power supplies

Package

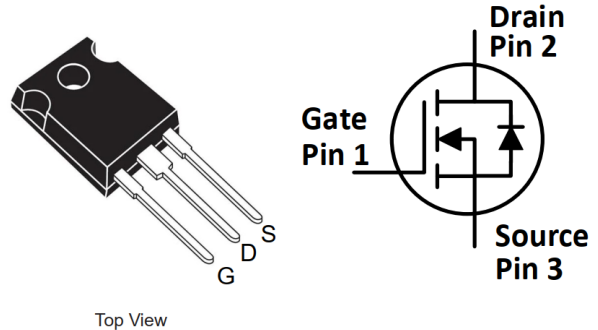

Part Number	Package
DTN70N65SC3	TO247-3

Absolute Maximum Ratings ($T_c=25^\circ\text{C}$ unless otherwise specified)

Symbol	Parameter	Value	Unit	Test Conditions	Note
V_{DS}	Drain-Source voltage	650	V	$V_{GS}=0\text{V}$, $I_b=100\mu\text{A}$	
$V_{GSmax}(\text{DC})$	Maximum DC voltage	-5 to 22	V	Static (DC)	
$V_{GSmax}(\text{Spike})$	Maximum spike voltage	-10 to 25	V	<1% duty cycle, and pulse width<200ns	
V_{GSon}	Recommended turn-on voltage	20 ± 0.5	V		
V_{GSoff}	Recommended turn-off voltage	-3.5 to -2	V		
I_b	Drain current (continuous)	72	A	$V_{GS}=20\text{V}$, $T_c=25^\circ\text{C}$	Fig. 21
		58	A	$V_{GS}=20\text{V}$, $T_c=100^\circ\text{C}$	
I_{bM}	Drain current (pulsed)	180	A	Pulse width limited by SOA	Fig. 24
P_{TOT}	Total power dissipation	348	W	$T_c=25^\circ\text{C}$	Fig. 22
T_{stg}	Storage temperature range	-55 to 175	$^\circ\text{C}$		
T_j	Operating junction temperature	-55 to 175	$^\circ\text{C}$		
T_L	Solder Temperature	260	$^\circ\text{C}$	wave soldering only allowed at leads, 1.6mm from case for 10 s	

Thermal Data

Symbol	Parameter	Value	Unit	Note
$R_{\theta(j-c)}$	Thermal Resistance from Junction to Case	0.431	$^\circ\text{C}/\text{W}$	Fig. 23

Electrical Characteristics ($T_c=25^\circ\text{C}$ unless otherwise specified)

Symbol	Parameter	Value			Unit	Test Conditions	Note
		Min.	Typ.	Max.			
I_{DSS}	Zero gate voltage drain current		3	100	μA	$V_{DS}=650\text{V}, V_{GS}=0\text{V}$	
I_{GSS}	Gate leakage current			± 100	nA	$V_{DS}=0\text{V}, V_{GS}=-5\sim 20\text{V}$	
V_{TH}	Gate threshold voltage	1.8	3.2	5	V	$V_{GS}=V_{DS}, I_D=6.1\text{mA}$	Fig. 8, 9
			2.2			$V_{GS}=V_{DS}, I_D=6.1\text{mA}$ @ $T_c=175^\circ\text{C}$	
R_{ON}	Static drain-source on-resistance		40	55	$\text{m}\Omega$	$V_{GS}=20\text{V}, I_D=20\text{A}$ @ $T_j=25^\circ\text{C}$	Fig. 4, 5, 6, 7
			53		$\text{m}\Omega$	$V_{GS}=20\text{V}, I_D=20\text{A}$ @ $T_j=175^\circ\text{C}$	
C_{iss}	Input capacitance		2692		pF	$V_{DS}=600\text{V}, V_{GS}=0\text{V},$ $f=1\text{MHz}, V_{AC}=25\text{mV}$	Fig. 16
C_{oss}	Output capacitance		179		pF		
C_{rss}	Reverse transfer capacitance		10.8		pF		
E_{oss}	C_{oss} stored energy		35.6		μJ		Fig. 17
Q_g	Total gate charge		110.8		nC	$V_{DS}=400\text{V}, I_D=20\text{A},$ $V_{GS}=-5\text{ to }20\text{V}$	Fig. 18
Q_{gs}	Gate-source charge		26.8		nC		
Q_{gd}	Gate-drain charge		35.7		nC		
R_g	Gate input resistance		2		Ω	$f=1\text{MHz}$	
E_{ON}	Turn-on switching energy		289.1		μJ	$V_{DS}=400\text{V}, I_D=30\text{A},$ $V_{GS}=-2\text{ to }20\text{V},$ $R_{G(\text{ext})}=3.3\Omega,$ $L=450\mu\text{H}$	Fig. 19, 20
E_{OFF}	Turn-off switching energy		117.1		μJ		
$t_{d(\text{on})}$	Turn-on delay time		24.7		ns		
t_r	Rise time		20.3				
$t_{d(\text{off})}$	Turn-off delay time		12.4				
t_f	Fall time		29.6				

Reverse Diode Characteristics ($T_c=25^\circ\text{C}$ unless otherwise specified)

Symbol	Parameter	Value			Unit	Test Conditions	Note
		Min.	Typ.	Max.			
V_{SD}	Diode forward voltage		4.0		V	$I_{SD}=20\text{A}, V_{GS}=0\text{V}$	Fig. 10, 11, 12
			3.6		V	$I_{SD}=20\text{A}, V_{GS}=0\text{V},$ $T_J=175^\circ\text{C}$	
t_{rr}	Reverse recovery time		23		ns	$V_{GS}=-2\text{V}/+20\text{V},$ $I_{SD}=30\text{A}, V_R=400\text{V},$ $di/dt=1700\text{A}/\mu\text{s},$	
Q_{rr}	Reverse recovery charge		161		nC		
I_{RRM}	Peak reverse recovery current		10.4		A	$R_{G(\text{ext})}=3.3\Omega$ $L=450\mu\text{H}$	

Typical Performance (curves)

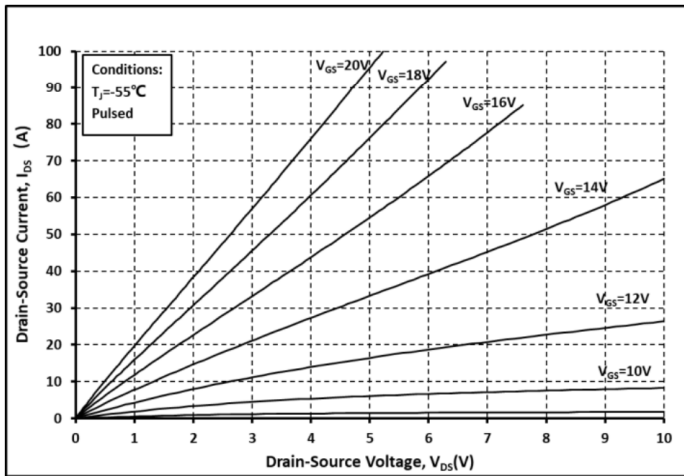

Fig. 1 Output Curve @ $T_j = -55^\circ\text{C}$

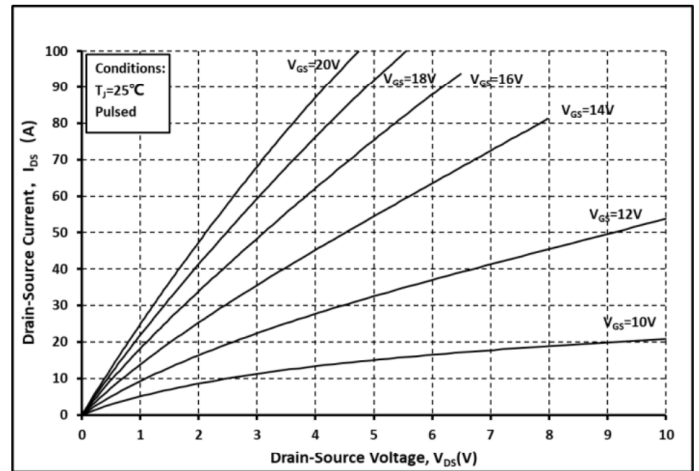

Fig. 2 Output Curve @ $T_j = 25^\circ\text{C}$

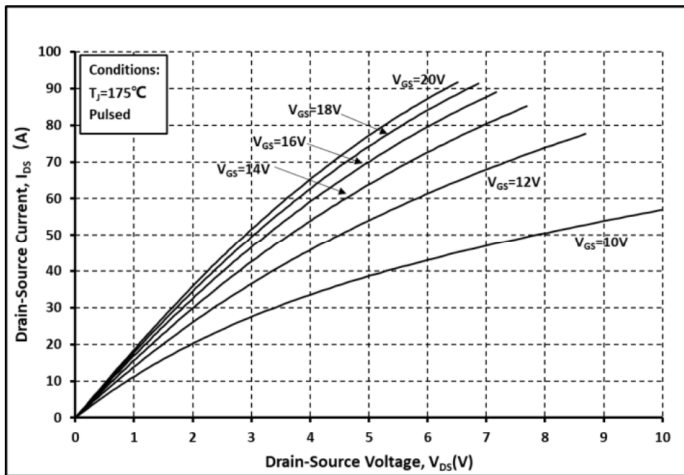

Fig. 3 Output Curve @ $T_j = 175^\circ\text{C}$

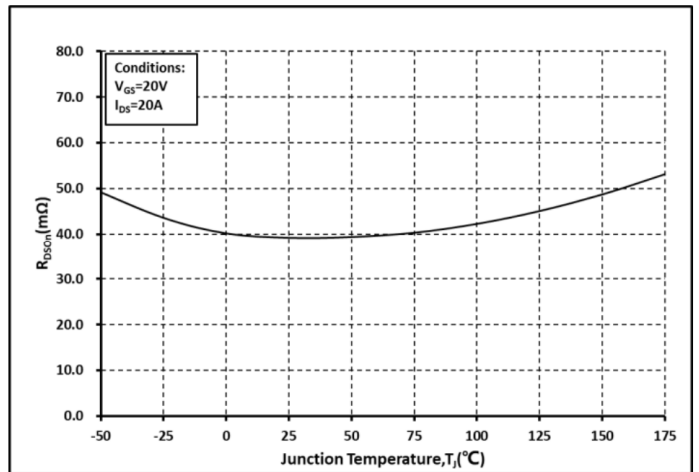

Fig. 4 $R_{DS(on)}$ vs. Temperature

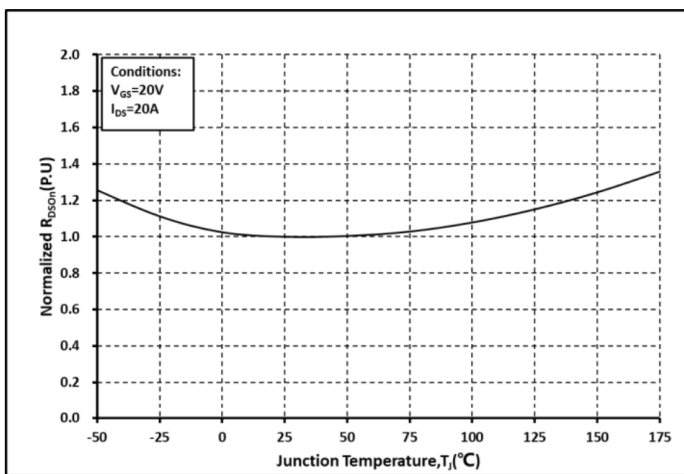

Fig. 5 Normalized $R_{DS(on)}$ vs. Temperature

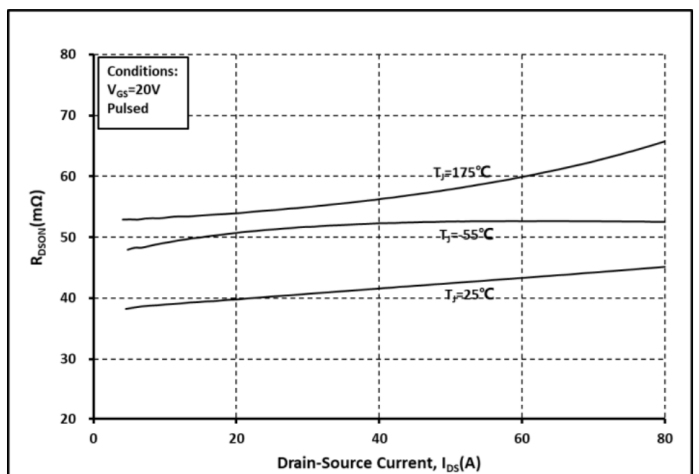

Fig. 6 $R_{DS(on)}$ vs. I_{DS} @ Various Temperature

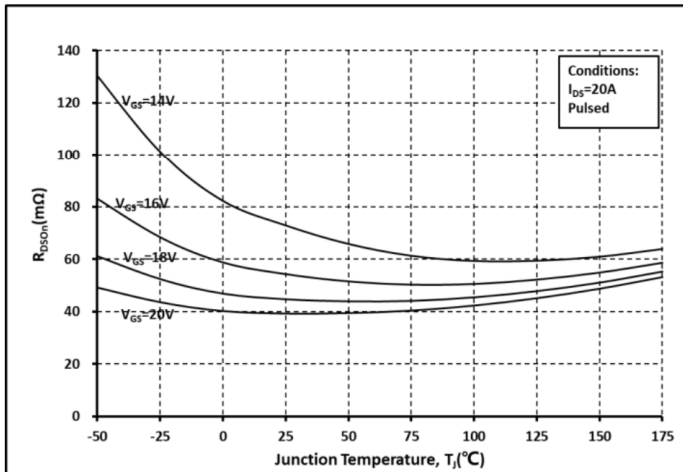

Fig. 7 Ron vs. Temperature @ Various V_{GS}

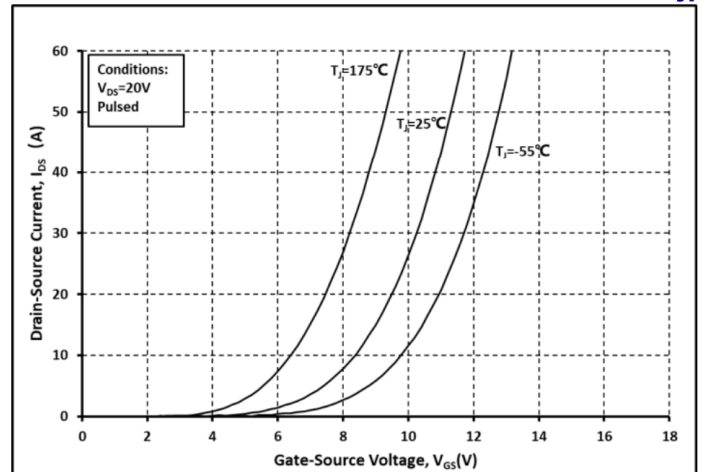

Fig. 8 Transfer Curves @ Various Temperature

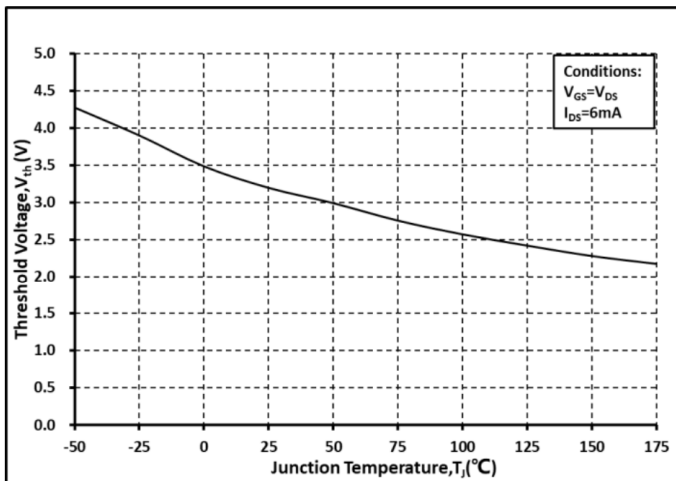

Fig. 9 Threshold Voltage vs. Temperature

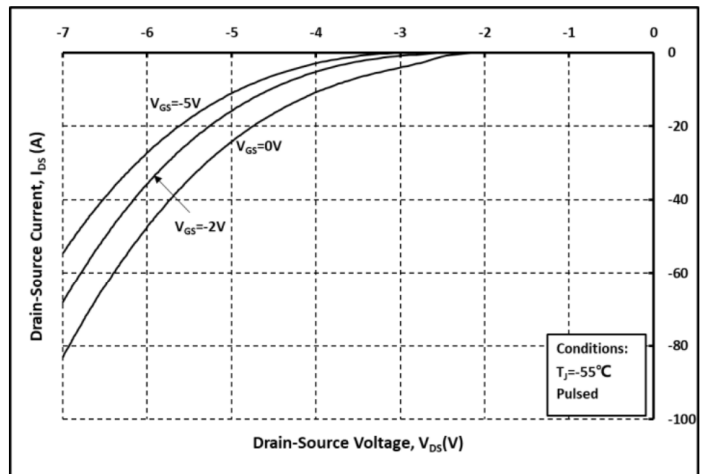

Fig. 10 Body Diode Curves @ $T_J = -55^\circ C$

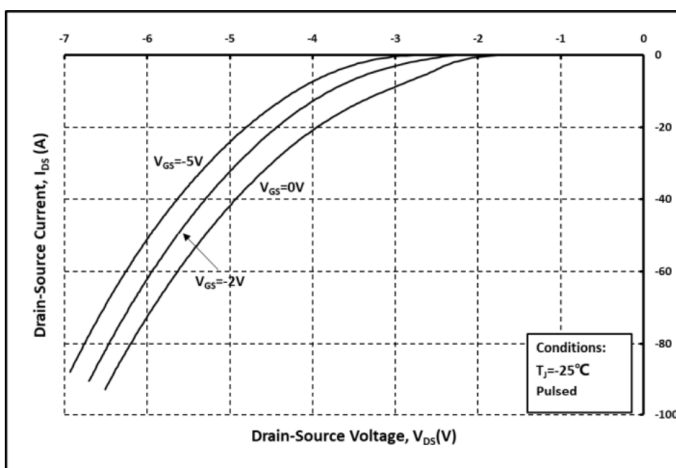

Fig. 11 Body Diode Curves @ $T_J = 25^\circ C$

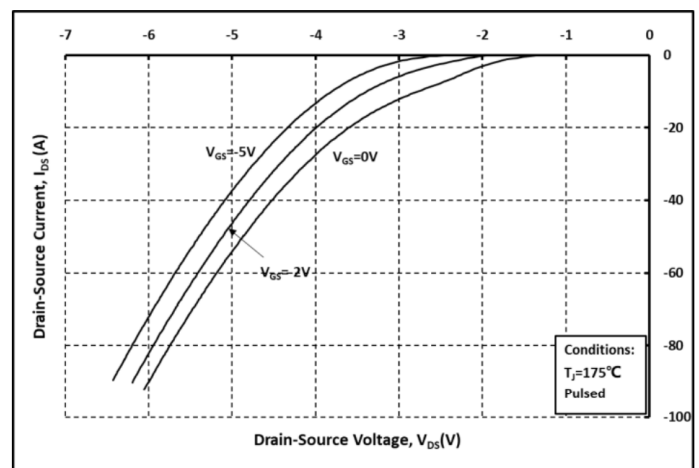

Fig. 12 Body Diode Curves @ $T_J = 175^\circ C$

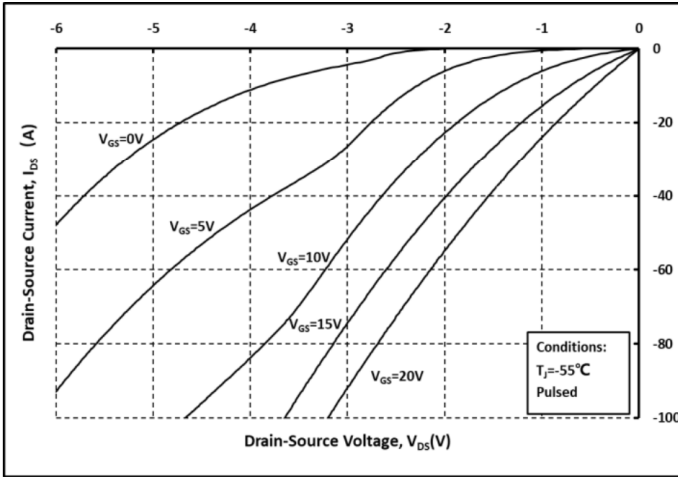

Fig. 13 3rd Quadrant Curves @ $T_j = -55^\circ\text{C}$

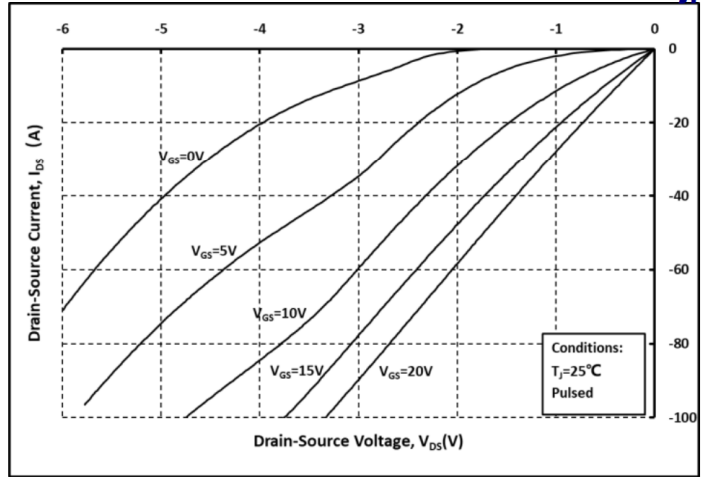

Fig. 14 3rd Quadrant Curves @ $T_j = 25^\circ\text{C}$

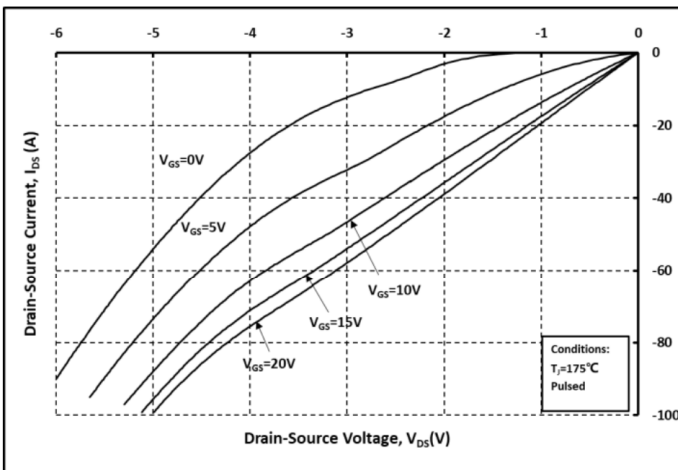

Fig. 15 3rd Quadrant Curves @ $T_j = 175^\circ\text{C}$

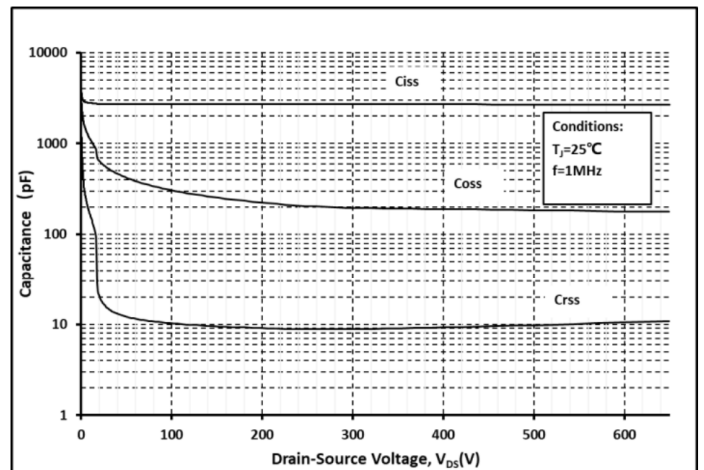

Fig. 16 Capacitance vs. V_{DS}

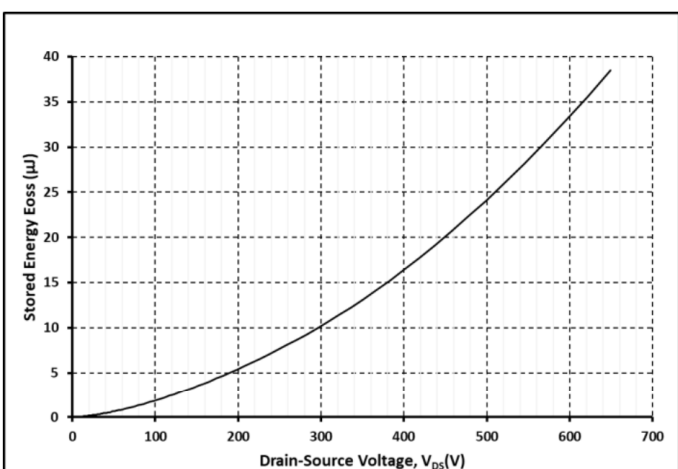

Fig. 17 Output Capacitor Stored Energy

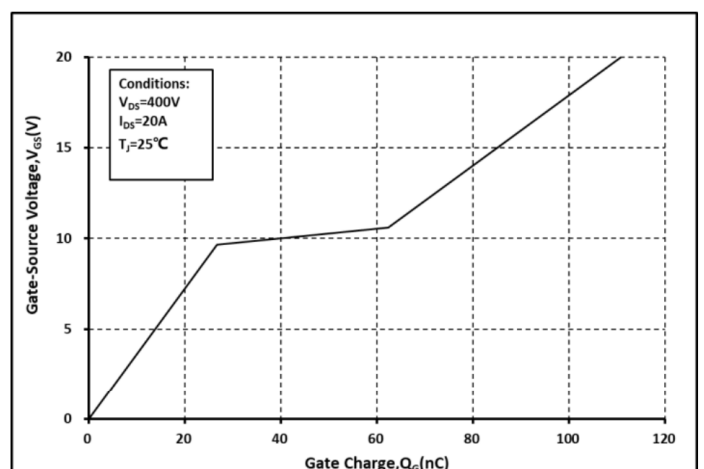

Fig. 18 Gate Charge Characteristics

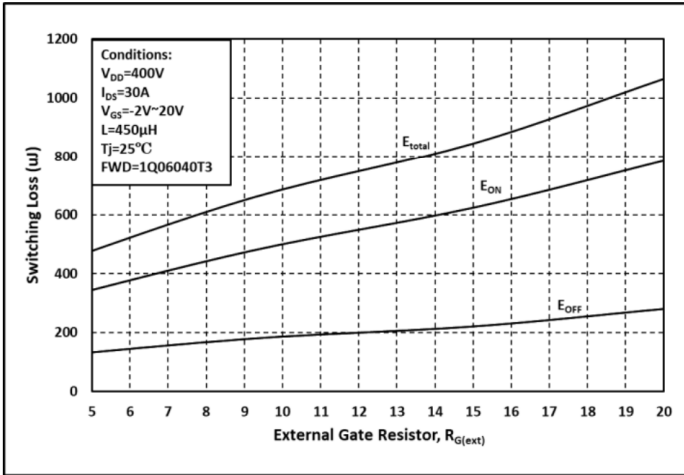

Fig. 19 Switching Energy vs. $R_{G(ext)}$

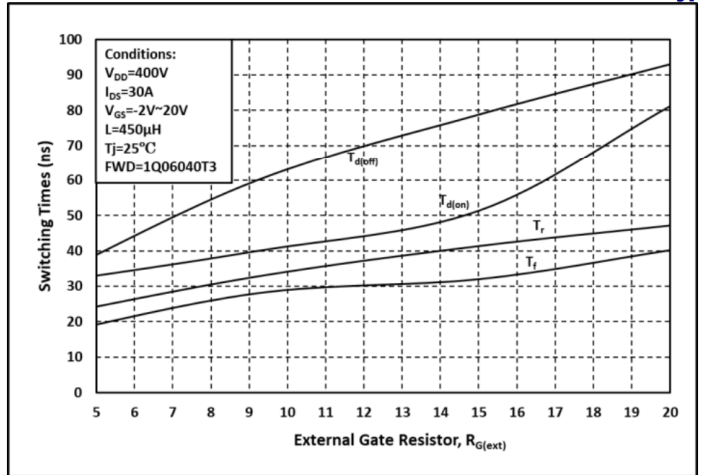

Fig. 20 Switching Times vs. $R_{G(ext)}$

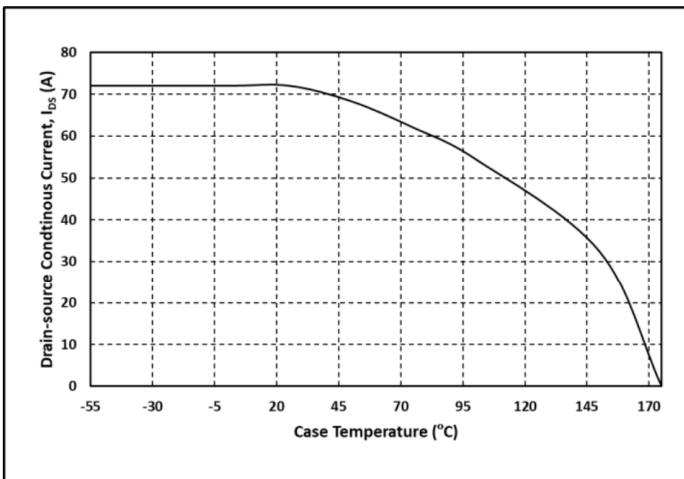

Fig. 21 Continuous Drain Current vs. Case Temperature

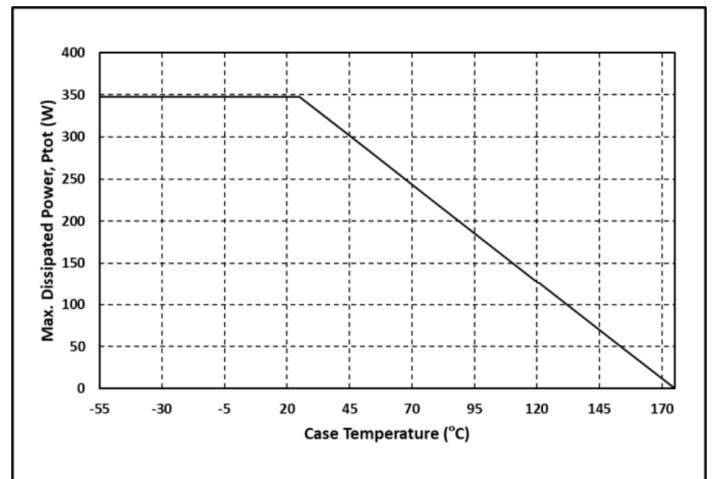

Fig. 22 Max. Power Dissipation Derating vs. Case Temperature

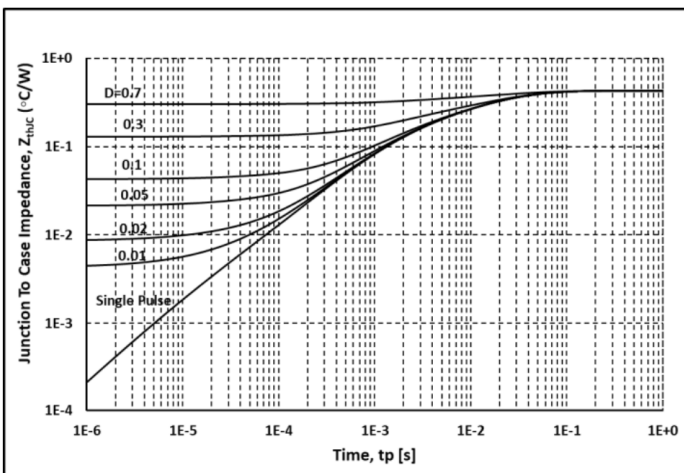

Fig. 23 Thermal Impedance

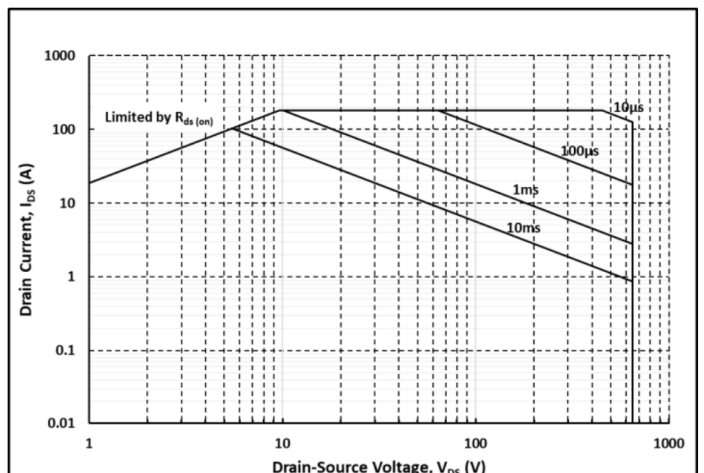
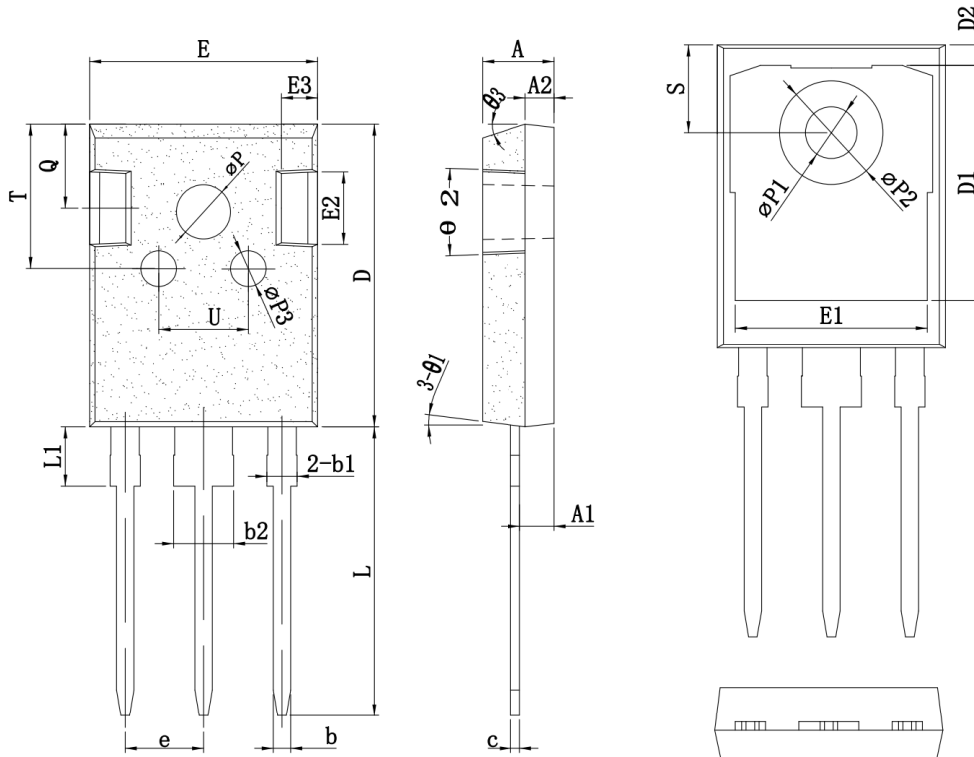

Fig. 24 Safe Operating Area

TO-247_3L PACKAGE OUTLINE



COMMON DIMENSIONS
(UNITS OF MEASURE=MILLIMETER)

SYMBOL	MIN	TYP	MAX	SYMBOL	MIN	TYP	MAX
A	4.60	5.00	5.40	e	2.10	5.44	5.70
A1	2.10	2.41	2.70	L	19.00	19.98	21.00
A2	1.70	2.00	2.30	L1	-	-	4.50
b	1.00	1.20	1.40	ΦP	3.30	3.70	4.00
b1	1.80	2.10	2.40	$\Phi P1$	3.25	3.55	3.85
b2	2.80	3.10	3.40	$\Phi P2$	6.80	7.18	7.60
C	0.45	0.60	0.75	$\Phi P3$	2.30	2.50	3.30
D	19.00	21.00	23.00	Q	5.50	5.80	6.30
D1	16.00	16.55	17.00	S	5.60	6.15	6.30
D2	0.95	1.20	1.45	T	9.50	10.00	10.50
E	15.70	15.80	16.50	U	6.00	-	8.00
E1	12.80	13.25	13.70	$\theta 1$	5°	7°	9°
E2	4.20	5.00	5.30	$\theta 2$	1°	3°	5°
E3	2.20	2.50	2.80	$\theta 3$	13°	15°	17°

Disclaimer

ALL PRODUCT, PRODUCT SPECIFICATIONS AND DATA ARE SUBJECT TO CHANGE WITHOUT NOTICE TO IMPROVE RELIABILITY, FUNCTION OR DESIGN OR OTHERWISE.

Din-Tek Intertechnology, Inc., its affiliates, agents, and employees, and all persons acting on its or their behalf (collectively, "Din-Tek"), disclaim any and all liability for any errors, inaccuracies or incompleteness contained in any datasheet or in any other disclosure relating to any product.

Din-Tek makes no warranty, representation or guarantee regarding the suitability of the products for any particular purpose or the continuing production of any product. To the maximum extent permitted by applicable law, Din-Tek disclaims (i) any and all liability arising out of the application or use of any product, (ii) any and all liability, including without limitation special, consequential or incidental damages, and (iii) any and all implied warranties, including warranties of fitness for particular purpose, non-infringement and merchantability.

Statements regarding the suitability of products for certain types of applications are based on Din-Tek's knowledge of typical requirements that are often placed on Din-Tek products in generic applications. Such statements are not binding statements about the suitability of products for a particular application. It is the customer's responsibility to validate that a particular product with the properties described in the product specification is suitable for use in a particular application. Parameters provided in datasheets and/or specifications may vary in different applications and performance may vary over time. All operating parameters, including typical parameters, must be validated for each customer application by the customer's technical experts. Product specifications do not expand or otherwise modify Din-Tek's terms and conditions of purchase, including but not limited to the warranty expressed therein.

Except as expressly indicated in writing, Din-Tek products are not designed for use in medical, life-saving, or life-sustaining applications or for any other application in which the failure of the Din-Tek product could result in personal injury or death. Customers using or selling Din-Tek products not expressly indicated for use in such applications do so at their own risk. Please contact authorized Din-Tek personnel to obtain written terms and conditions regarding products designed for such applications.

No license, express or implied, by estoppel or otherwise, to any intellectual property rights is granted by this document or by any conduct of Din-Tek. Product names and markings noted herein may be trademarks of their respective owners.

Material Category Policy

Din-Tek Intertechnology, Inc. hereby certifies that all its products that are identified as RoHS-Compliant fulfill the definitions and restrictions defined under Directive 2011/65/EU of The European Parliament and of the Council of June 8, 2011 on the restriction of the use of certain hazardous substances in electrical and electronic equipment (EEE) - recast, unless otherwise specified as non-compliant.

Please note that some Din-Tek documentation may still make reference to RoHS Directive 2002/95/EC. We confirm that all the products identified as being compliant to Directive 2002/95/EC conform to Directive 2011/65/EU.

Din-Tek Intertechnology, Inc. hereby certifies that all its products that are identified as Halogen-Free follow Halogen-Free requirements as per JEDEC JS709A standards. Please note that some Din-Tek documentation may still make reference to the IEC 61249-2-21 definition. We confirm that all the products identified as being compliant to IEC 61249-2-21 conform to JEDEC JS709A standards.