

650V 8A 1.18Ω N-ch Power MOSFET

Description

DT2 MOS is DIN-TEK 2nd generation VDMOS family that is dramatic reduction in on-resistance and ultra-low gate charge for applications requiring high power density and high efficiency. And it is very robust and RoHS compliant.

Features

- Typ. $R_{DS(on)}=1.18\Omega@V_{GS}=10V$
- 100% avalanche tested
- RoHS Compliant

Applications

- SMPS
- Charger
- DC-DC

TO-220

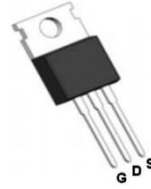

TO-220F



TO-252

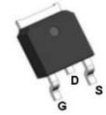

TO-251-L4.0

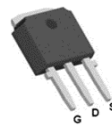

TO-251-L9.4

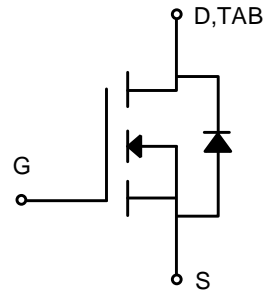

Absolute Maximum Ratings ($T_c=25^{\circ}C$)

Parameter	Symbol	DTP8N65	DTU8N65/DTL8N65	DTP8N65F	Unit
Drain-source voltage	V_{DSS}	650			V
Gate-source voltage	V_{GS}	± 30			V
Continuous drain current	I_D	8			A
Pulsed drain current ¹	I_{DM}	32			A
Avalanche energy, single pulse ²	E_{AS}	105			mJ
Power dissipation	P_D	125	55	38	W
Derate above 25°C		1	0.4	0.3	W/°C
Operating junction temperature	T_j	-55~150			°C
Storage temperature	T_{stg}	-55~150			°C
Continuous diode forward current	I_S	8			A
Diode pulse current ¹	I_{Spulse}	32			A

Thermal Characteristic

Thermal resistance,junction-to-case	$R_{\theta JC}$	1	2.27	3.29	°C/W
Thermal resistance,junction-to-ambient	$R_{\theta JA}$	62.5	110	62.5	°C/W

Electrical Characteristics of MOSFET

				Min.	Typ.	Max.	
Drain-source break down voltage	BV_{DSS}	$I_D=250\mu A, V_{GS}=0V$	$T_C=25^\circ C$	650	-	-	V
Gate threshold voltage	$V_{GS(th)}$	$I_D=250\mu A, V_{DS}=V_{GS}$	$T_J=25^\circ C$	2.0	-	4.0	V
Drain-source leakage current	I_{DSS}	$V_{DS}=650V, V_{GS}=0V$	$T_J=25^\circ C$	-	-	1	μA
		$V_{DS}=520V, V_{GS}=0V$	$T_J=125^\circ C$	-	-	100	μA
Gate-source leakage current,forward	I_{GSSF}	$V_{DS}=0V, V_{GS}=30V$	$T_J=25^\circ C$	-	-	100	nA
Gate-source leakage current,reverse	I_{GSSR}	$V_{DS}=0V, V_{GS}=-30V$	$T_J=25^\circ C$	-	-	-100	nA
Drain-source on-state resistance ³	$R_{DS(ON)}$	$V_{GS}=10V, I_D=4A$	$T_J=25^\circ C$	-	1.18	1.36	Ω
Transconductance ³	G_{fs}	$V_{DS}=20V$	$T_J=25^\circ C$	-	6.2	-	S

Dynamic Characteristics of MOSFET ($T_C=25^\circ C$)

				Min.	Typ.	Max.	
Input capacitance	C_{iss}	$f=1MHz, V_{DS}=25V, V_{GS}=0V$		-	1103	-	pF
Output capacitance	C_{oss}			-	94	-	pF
Reverse transfer capacitance	C_{rss}			-	10	-	pF
Gate to source charge	Q_{gs}	$V_{DD}=520V$		-	7.4	-	nC
Gate to drain charge	Q_{gd}	$I_D=8A$		-	7	-	nC
Total gate charge	Q_g	$V_{GS}=0$ to 10V		-	24.4	-	nC

Switching Characteristics of MOSFET ($T_C=25^\circ C$)

				Min.	Typ.	Max.	
Turn-on delay time	t_{don}	$V_{DS}=325V, I_D=8A, R_G=25\Omega, V_{GS}=0$ to 10V		-	19	-	ns
Rise time	t_r			-	21	-	ns
Turn-off delay time	t_{doff}			-	80	-	ns
Fall time	t_f			-	30	-	ns

Characteristics of Body Diode ($T_C=25^\circ C$)

				Min.	Typ.	Max.	
Forward voltage	V_{SD}	$I_{SD}=8A, V_{GS}=0V$		-	-	1.4	V
Reverse recovery time	t_{rr}	$V_{DS}=50V, I_S=8A,$		-	280	-	ns
Reverse recovery current	I_{rr}	$V_{GS}=10V$		-	12	-	A
Recovery charge	Q_{rr}	$di/dt=100A/\mu s$		-	1.7	-	μC

Notes:

1. Repetitive rating, pulse width limited by junction temperature $T_{J(MAX)}=150^\circ C$.
2. The E_{AS} data shows Max. rating . The test condition is $V_{DD}=50V, V_{GS}=10V, L=10mH, I_{AS}=4.6A, T_C=25^\circ C$.
3. The data tested by pulsed , pulse width $\leq 300\mu s$, duty cycle $\leq 2\%$.

TYPICAL CHARACTERISTICS

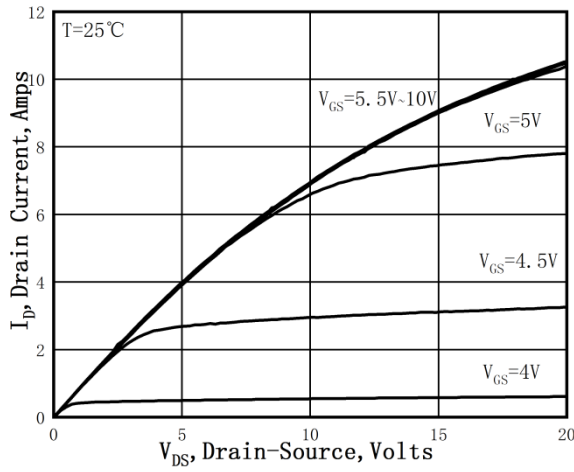

Figure 1. On-Region Characteristics

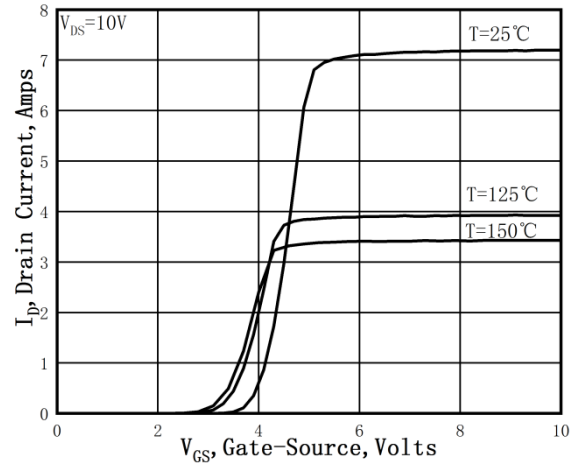

Figure 2. Transfer Characteristics

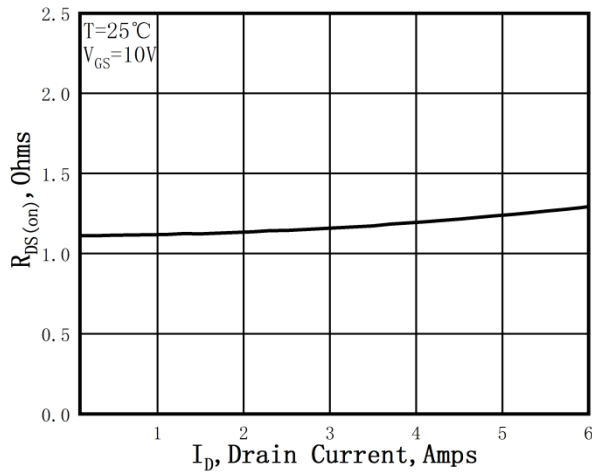

Figure 3. Static Drain-Source On Resistance

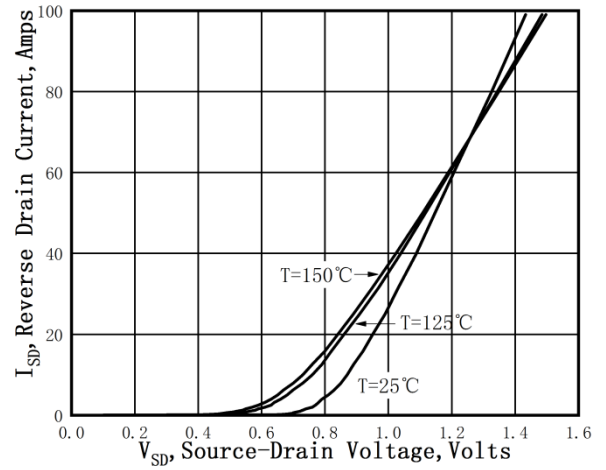

Figure 4. Typical Body Diode Transfer Characteristics

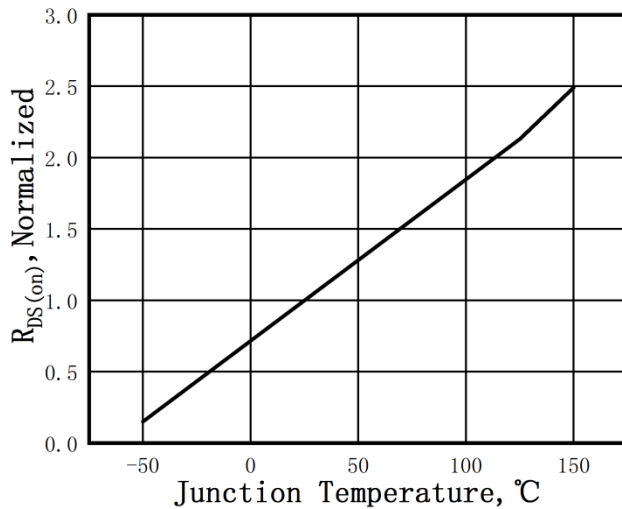

Figure 5. Normalized $R_{DS(on)}$ vs. Temperature

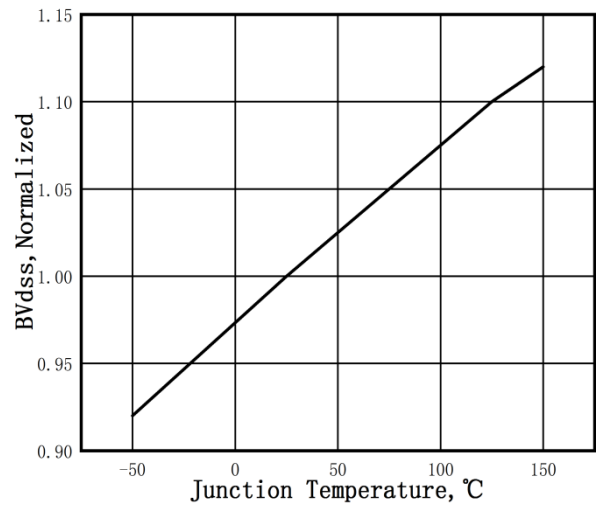

Figure 6. Normalized BV_{DSS} vs. Temperature

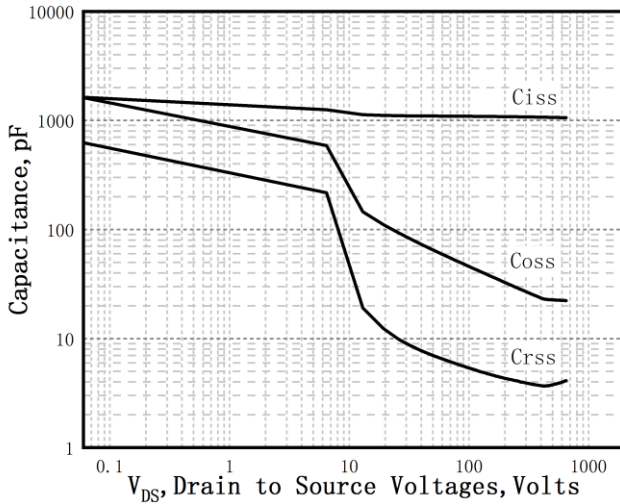

Figure 7. Capacitance Characteristics

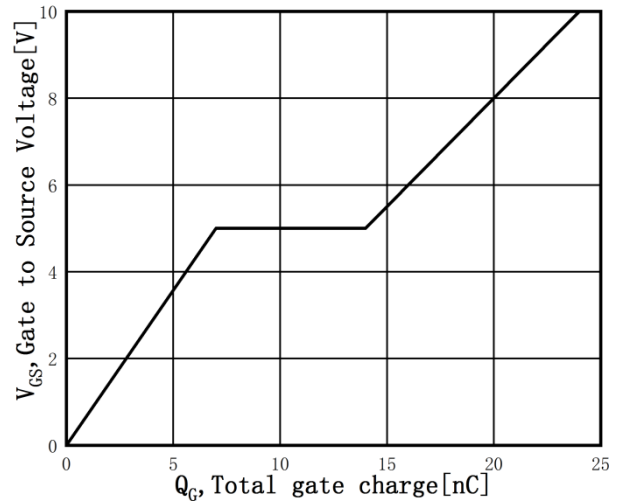

Figure 8. Gate Charge Characteristics

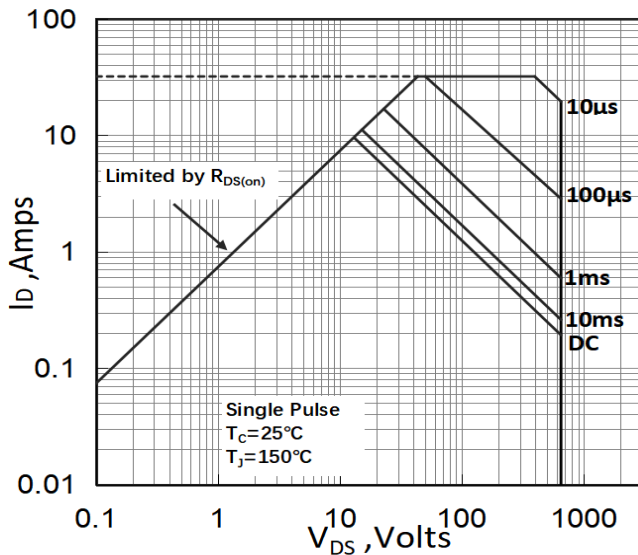

Figure 9. Maximum Safe Operating Area (TO-220)

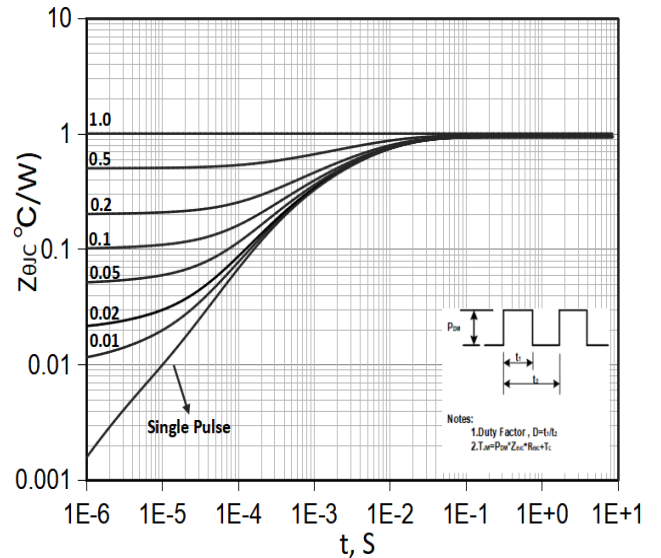

Figure 10. Transient Thermal Response Curve (TO-220)

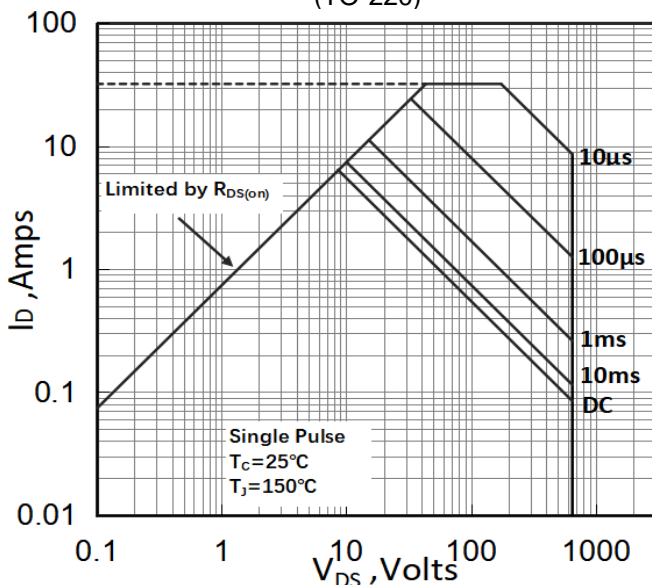

Figure 11. Maximum Safe Operating Area (TO-252/TO-251)

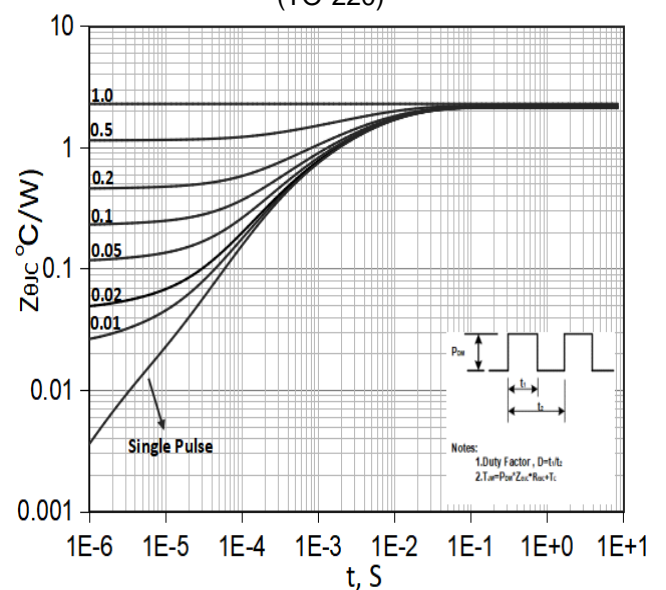

Figure 12. Transient Thermal Response Curve (TO-252/TO-251)

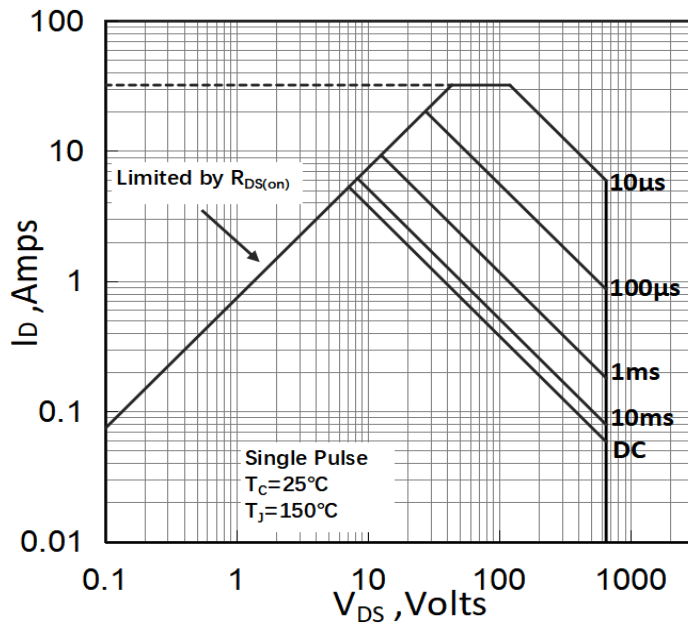

Figure 13. Maximum Safe Operating Area (TO-220F)

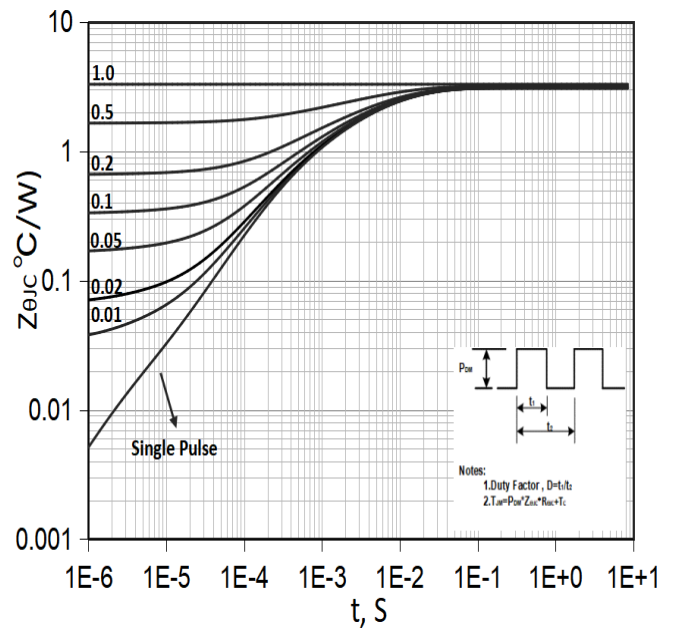
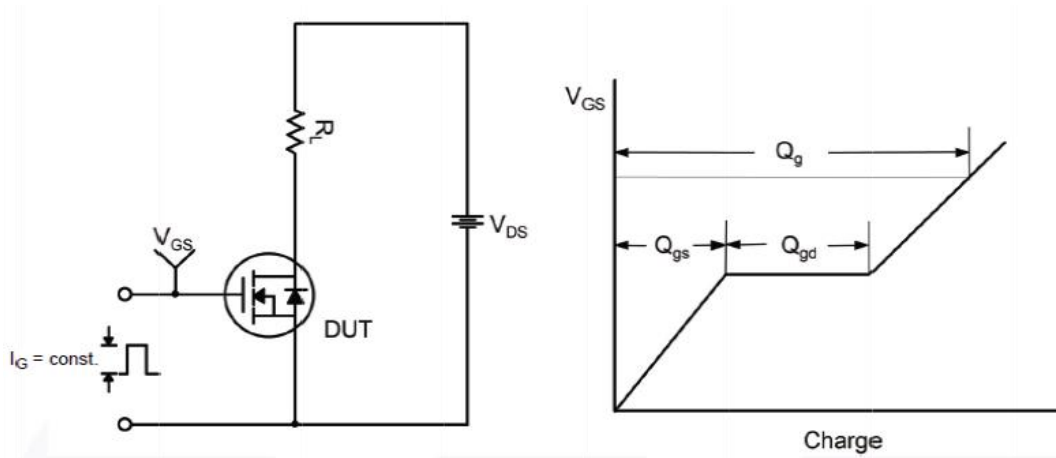

Figure 14. Transient Thermal Response Curve (TO-220F)

Test Circuit

Gate Charge Test Circuit & Waveform



Switching Test Circuit & Waveforms

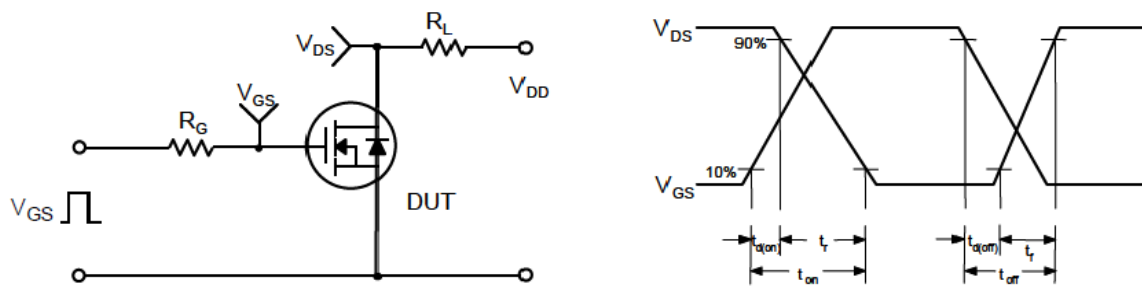

Unclamped Inductive Switching Test Circuit & Waveforms

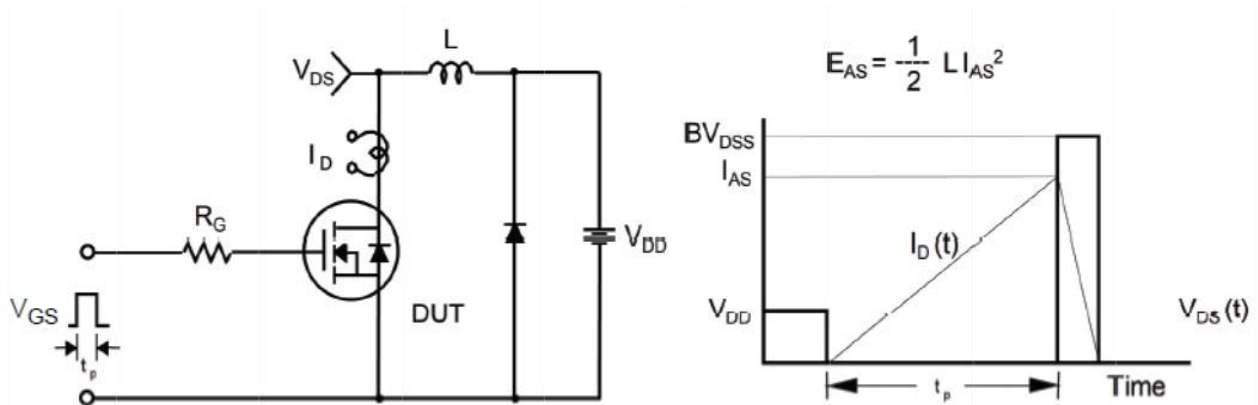

Mechanical Dimensions for TO-220F

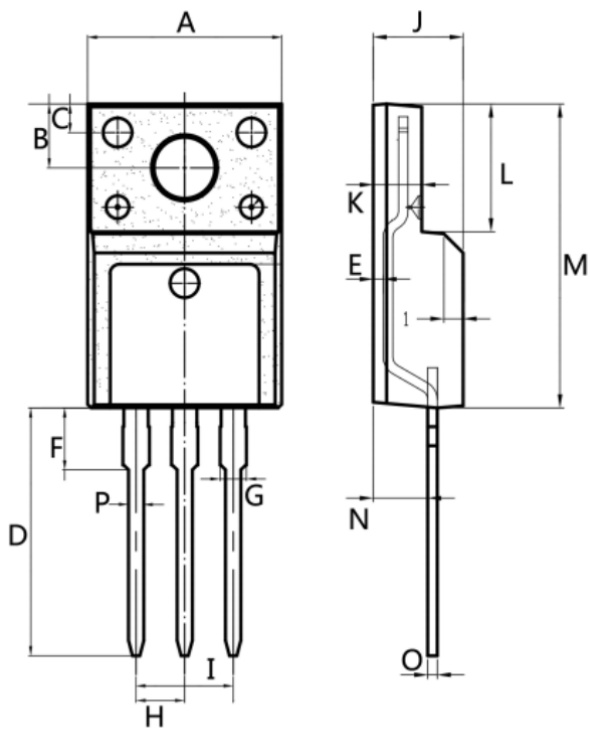

COMMON DIMENSIONS

SYMBOL	MM	
	MIN	MAX
A	9.95	10.36
B	2.95	3.55
C	1.25	1.6
D	12.64	13.5
E	0.40	0.60
F	2.80	3.80
G	1.14	1.58
H	2.44	2.64
I	4.88	5.26
J	4.50	4.90
K	2.34	2.80
L	6.48	6.90
M	15.40	16.07
N	2.66	3.50
O	0.40	0.64
P	0.70	0.94

Mechanical Dimensions for TO-220

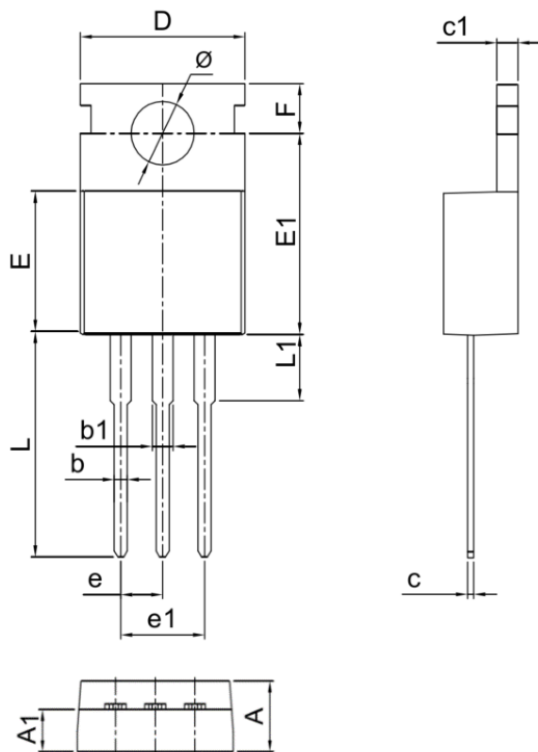

COMMON DIMENSIONS

SYMBOL	MM	
	MIN	MAX
A	4.30	4.70
A1	2.30	2.82
b	0.70	0.94
b1	1.17	1.41
c	0.30	0.64
c1	1.17	1.44
D	9.70	10.20
E	8.50	9.30
E1	12.00	12.50
e	2.44	2.64
e1	4.88	5.26
F	2.60	2.94
L	13.00	14.00
L1	3.385	4.20
Ø	3.74	3.95

Mechanical Dimensions for TO-252

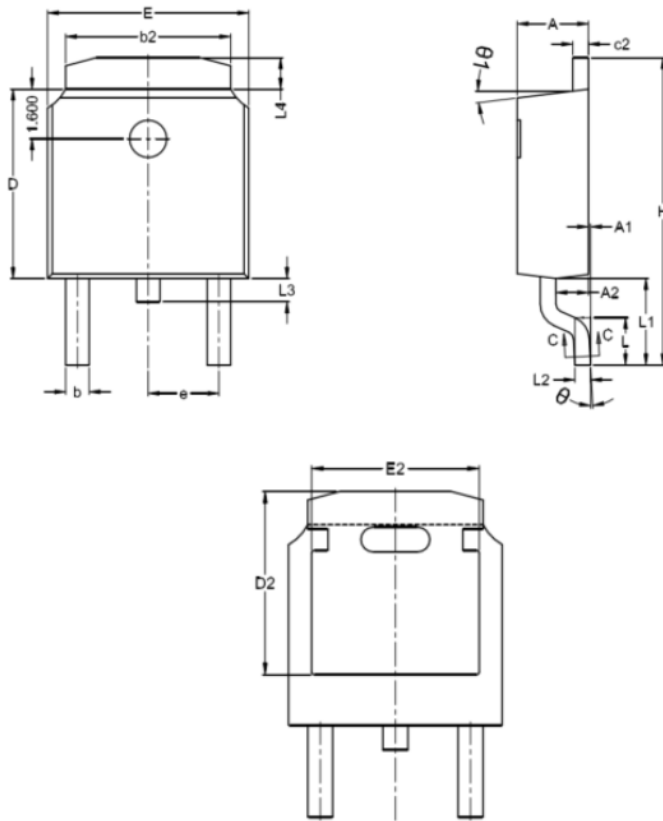

COMMON DIMENSIONS

SYMBOL	MM	
	MIN	MAX
A	2.10	2.50
A1	0	0.15
b	0.7	0.9
b2	5.13	5.54
c	0.44	0.65
c2	0.45	0.65
D	6.00	6.20
D2	5.37	5.78
E	6.30	6.90
E2	4.90	5.30
e	2.23	2.33
H	9.7	10.5
L	1.38	1.73
L1	2.58	3.00
L2	0.50	0.52
L3	0.60	1.00
L4	0.81	1.42

Mechanical Dimensions for TO-251-L4.0

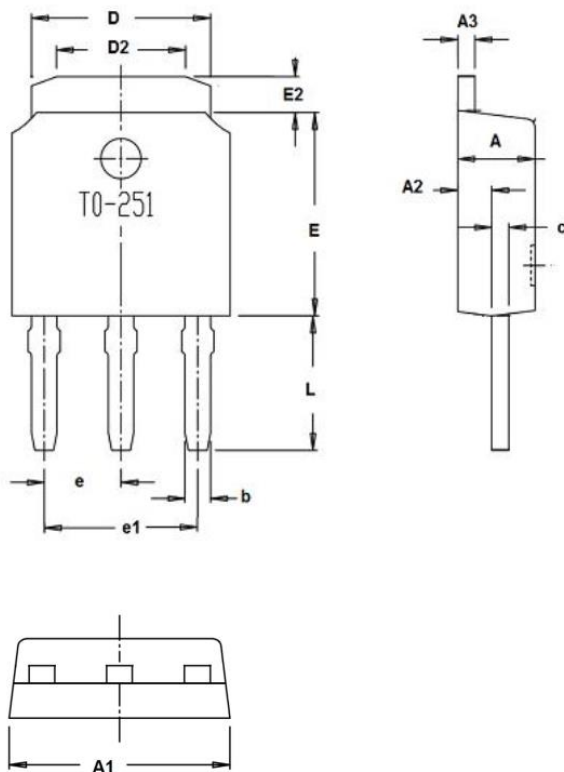

COMMON DIMENSIONS

SYMBOL	MM	
	MIN	MAX
A	2.15	2.45
A1	6.3	6.9
A2	0.9	1.1
A3	Typ0.5	
b	0.74	0.86
c	0.9	1.1
D	5.33	5.53
D2	3.56	4.05
E	6.0	6.2
e	Typ2.29	
e1	Typ4.58	
L	3.7	4.3

Mechanical Dimensions for TO-251-L9.4

COMMON DIMENSIONS

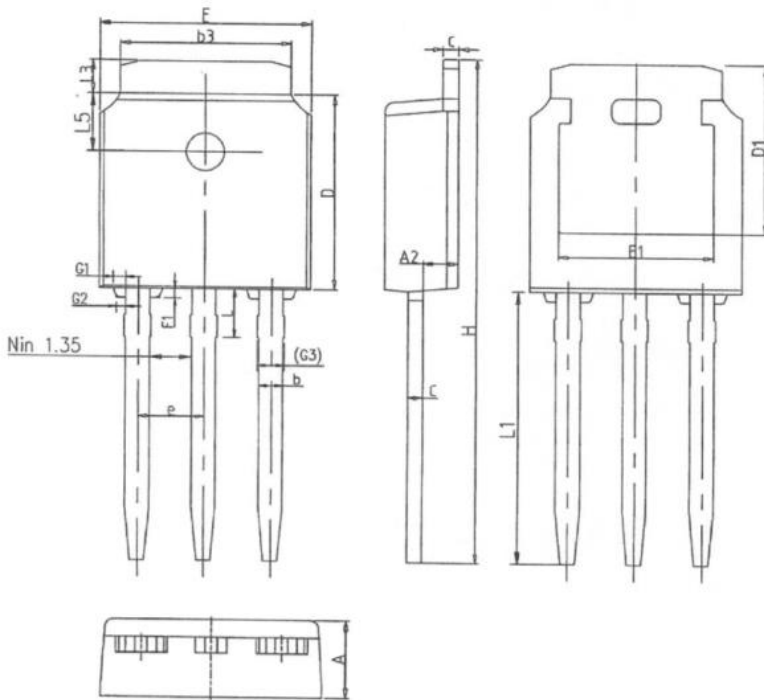

SYMBOL	MM	
	MIN	MAX
A	2.20	2.40
A2	0.97	1.17
b	0.58	0.78
b3	5.20	5.50
c	0.43	0.63
D	5.98	6.22
D1	5.30REF	
E	6.40	6.80
e	1.98	2.59
F1	0.23	0.37
G2	0.33	0.47
G3	0.64	0.80
H	16.22	16.82
L1	9.15	9.65
L3	0.88	1.28

Ordering Information

Part	Package	Marking	Packing method	Minimum packing number
DTP8N65F	TO-220F	DTP8N65F	Tube	50 / Tube
DTP8N65	TO-220	DTP8N65	Tube	50 / Tube
DTU8N65	TO-252	DTU8N65	Tape and reel	2.5K / Reel
DTL8N65	TO-251-L4.0	DTL8N65	Tube	80 / Tube
	TO-251-L9.4		Tube	75 / Tube

Disclaimer

ALL PRODUCT, PRODUCT SPECIFICATIONS AND DATA ARE SUBJECT TO CHANGE WITHOUT NOTICE TO IMPROVE RELIABILITY, FUNCTION OR DESIGN OR OTHERWISE.

Din-Tek Intertechnology, Inc., its affiliates, agents, and employees, and all persons acting on its or their behalf (collectively, "Din-Tek"), disclaim any and all liability for any errors, inaccuracies or incompleteness contained in any datasheet or in any other disclosure relating to any product.

Din-Tek makes no warranty, representation or guarantee regarding the suitability of the products for any particular purpose or the continuing production of any product. To the maximum extent permitted by applicable law, Din-Tek disclaims (i) any and all liability arising out of the application or use of any product, (ii) any and all liability, including without limitation special, consequential or incidental damages, and (iii) any and all implied warranties, including warranties of fitness for particular purpose, non-infringement and merchantability.

Statements regarding the suitability of products for certain types of applications are based on Din-Tek's knowledge of typical requirements that are often placed on Din-Tek products in generic applications. Such statements are not binding statements about the suitability of products for a particular application. It is the customer's responsibility to validate that a particular product with the properties described in the product specification is suitable for use in a particular application. Parameters provided in datasheets and/or specifications may vary in different applications and performance may vary over time. All operating parameters, including typical parameters, must be validated for each customer application by the customer's technical experts. Product specifications do not expand or otherwise modify Din-Tek's terms and conditions of purchase, including but not limited to the warranty expressed therein.

Except as expressly indicated in writing, Din-Tek products are not designed for use in medical, life-saving, or life-sustaining applications or for any other application in which the failure of the Din-Tek product could result in personal injury or death. Customers using or selling Din-Tek products not expressly indicated for use in such applications do so at their own risk. Please contact authorized Din-Tek personnel to obtain written terms and conditions regarding products designed for such applications.

No license, express or implied, by estoppel or otherwise, to any intellectual property rights is granted by this document or by any conduct of Din-Tek. Product names and markings noted herein may be trademarks of their respective owners.

Material Category Policy

Din-Tek Intertechnology, Inc. hereby certifies that all its products that are identified as RoHS-Compliant fulfill the definitions and restrictions defined under Directive 2011/65/EU of The European Parliament and of the Council of June 8, 2011 on the restriction of the use of certain hazardous substances in electrical and electronic equipment (EEE) - recast, unless otherwise specified as non-compliant.

Please note that some Din-Tek documentation may still make reference to RoHS Directive 2002/95/EC. We confirm that all the products identified as being compliant to Directive 2002/95/EC conform to Directive 2011/65/EU.

Din-Tek Intertechnology, Inc. hereby certifies that all its products that are identified as Halogen-Free follow Halogen-Free requirements as per JEDEC JS709A standards. Please note that some Din-Tek documentation may still make reference to the IEC 61249-2-21 definition. We confirm that all the products identified as being compliant to IEC 61249-2-21 conform to JEDEC JS709A standards.