

N - Channel 30 V (D-S) MOSFET

| PRODUCT SUMMARY | | | |
|---------------------|--------------------------------|---------------------------------|-----------------------|
| V _{DS} (V) | R _{DS(on)} (mΩ)(Typ.) | I _D (A) ^a | Q _g (Typ.) |
| 30 | 8 at V _{GS} = 10 V | 12 | 4.5 nC |
| | 12 at V _{GS} = 4.5 V | | |

FEATURES

- DT-Trench MOSFET
- 100 % R_g and UIS Tested
- Low RDS(ON)
- Low Gate Charge



RoHS
COMPLIANT

APPLICATIONS

- Battery charging and discharging for battery pack
- Power switch for Adaptor/ Charger

PDFN 3.3x3.3-8L Pin Configuration

Top View

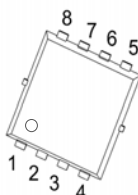

Bottom View

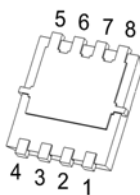

Top View

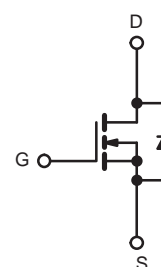
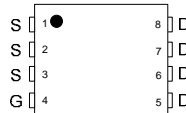

N-Channel MOSFET

| ABSOLUTE MAXIMUM RATINGS (T _C = 25 °C, unless otherwise noted) | | | |
|---|-----------------------------------|-------------------------|------|
| PARAMETER | SYMBOL | LIMIT | UNIT |
| Drain-Source Voltage | V _{DS} | 30 | V |
| Gate-Source Voltage | V _{GS} | ± 20 | |
| Continuous Drain Current (T _J = 150 °C) ^a | I _D | T _C = 25 °C | 12 |
| | | T _C = 100 °C | 9.4 |
| Pulsed Drain Current ^b | I _{DM} | 50 | A |
| Single Avalanche Energy | E _{AS} | 33.8 | mJ |
| Maximum Power Dissipation ^c | P _D | T _C = 25 °C | 21 |
| | | T _C = 100 °C | 8.3 |
| Operating Junction and Storage Temperature Range | T _J , T _{stg} | - 55 to +150 | °C |

| THERMAL RESISTANCE RATINGS | | | |
|--|-------------------|-----|------|
| PARAMETER | SYMBOL | MAX | UNIT |
| Junction-to-Ambient (PCB Mount) ^d | R _{thJA} | 65 | °C/W |
| Junction-to-Case (Drain) | R _{thJC} | 6 | |

Notes

- Calculated continuous current based on maximum allowable junction temperature.
- Repetitive rating; pulse width limited by max. junction temperature.
- P_d is based on max. junction temperature, using junction-case thermal resistance.
- The value of R_{thJA} is measured with the device mounted on 1 in 2 FR-4 board with 2oz. Copper, in a still air environment with T_a=25 °C.

| SPECIFICATIONS ($T_J = 25\text{ }^\circ\text{C}$, unless otherwise noted) | | | | | | |
|--|--------------|--|------|------|-----------|---------------|
| PARAMETER | SYMBOL | TEST CONDITIONS | MIN. | TYP. | MAX. | UNIT |
| Static | | | | | | |
| Drain-Source Breakdown Voltage | V_{DS} | $V_{GS} = 0\text{ V}, I_D = 250\text{ }\mu\text{A}$ | 30 | - | - | V |
| Gate Threshold Voltage | $V_{GS(th)}$ | $V_{DS} = V_{GS}, I_D = 250\text{ }\mu\text{A}$ | 1.0 | - | 3.0 | |
| Gate-Body Leakage | I_{GSS} | $V_{DS} = 0\text{ V}, V_{GS} = \pm 20\text{ V}$ | - | - | ± 100 | nA |
| Zero Gate Voltage Drain Current | I_{DSS} | $V_{DS} = 30\text{ V}, V_{GS} = 0\text{ V}$ | - | - | 1 | μA |
| | | $V_{DS} = 24\text{ V}, V_{GS} = 0\text{ V}, T_J = 55\text{ }^\circ\text{C}$ | - | - | 5 | |
| On-State Drain Current ^a | $I_{D(on)}$ | $V_{DS} \geq 5\text{ V}, V_{GS} = 5\text{ V}$ | 12 | - | - | A |
| Drain-Source On-State Resistance ^a | $R_{DS(on)}$ | $V_{GS} = 10\text{ V}, I_D = 12\text{ A}$ | - | 8 | 9.8 | m Ω |
| | | $V_{GS} = 4.5\text{ V}, I_D = 12\text{ A}$ | - | 12 | 15.8 | |
| Forward Transconductance ^a | g_{fs} | $V_{DS} = 5\text{ V}, I_D = 12\text{ A}$ | - | 45 | - | S |
| Dynamic ^b | | | | | | |
| Input Capacitance | C_{iss} | $V_{GS} = 0\text{ V}, V_{DS} = 15\text{ V}, f = 1\text{ MHz}$ | - | 562 | - | pF |
| Output Capacitance | C_{oss} | | - | 274 | - | |
| Reverse Transfer Capacitance | C_{rss} | | - | 28 | - | |
| Total Gate Charge ^c | Q_g | $V_{DS} = 15\text{ V}, V_{GS} = 10\text{ V}, I_D = 12\text{ A}$ | - | 8.9 | - | nC |
| Gate-Source Charge ^c | Q_{gs} | | - | 2.4 | - | |
| Gate-Drain Charge ^c | Q_{gd} | | - | 1.6 | - | |
| Gate Resistance | R_g | $f = 1\text{ MHz}$ | - | 3 | - | Ω |
| Turn-On Delay Time ^c | $t_{d(on)}$ | $V_{DS} = 15\text{ V}, I_D = 12\text{ A}, R_g = 3\text{ }\Omega$ $V_{GS} = 10\text{ V}$ | - | 5 | - | ns |
| Rise Time ^c | t_r | | - | 3.7 | - | |
| Turn-Off Delay Time ^c | $t_{d(off)}$ | | - | 18.5 | - | |
| Fall Time ^c | t_f | | - | 3.2 | - | |
| Drain-Source Body Diode Ratings and Characteristics ^b ($T_C = 25\text{ }^\circ\text{C}$) | | | | | | |
| Continuous Source-Drain Diode Current | I_S | $T_C = 25\text{ }^\circ\text{C}$ | - | - | 12 | A |
| Pulsed Current ($t = 100\text{ }\mu\text{s}$) | I_{SM} | | - | - | 50 | A |
| Forward Voltage ^a | V_{SD} | $I_F = 1\text{ A}, V_{GS} = 0\text{ V}$ | - | - | 1 | V |

Notes

- Pulse test; pulse width $\leq 300\text{ }\mu\text{s}$, duty cycle $\leq 2\%$.
- Guaranteed by design, not subject to production testing.
- Independent of operating temperature.

Stresses beyond those listed under "Absolute Maximum Ratings" may cause permanent damage to the device. These are stress ratings only, and functional operation of the device at these or any other conditions beyond those indicated in the operational sections of the specifications is not implied. Exposure to absolute maximum rating conditions for extended periods may affect device reliability.

TYPICAL CHARACTERISTICS (25°C , unless otherwise noted)

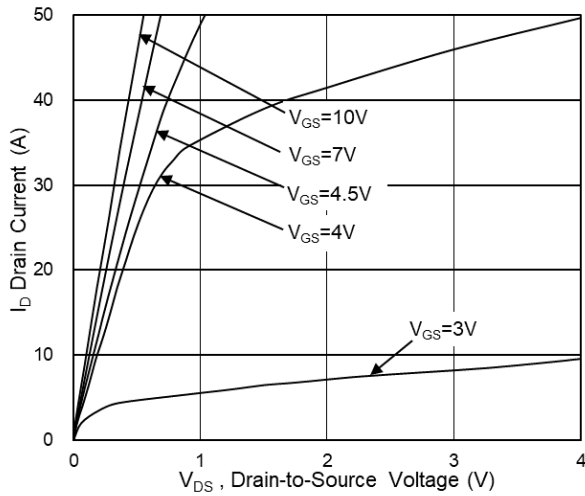

Typical Output Characteristics

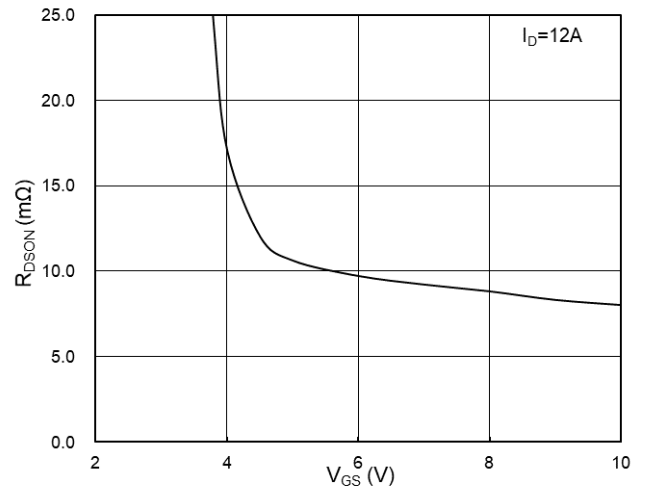

On-Resistance vs G-S Voltage

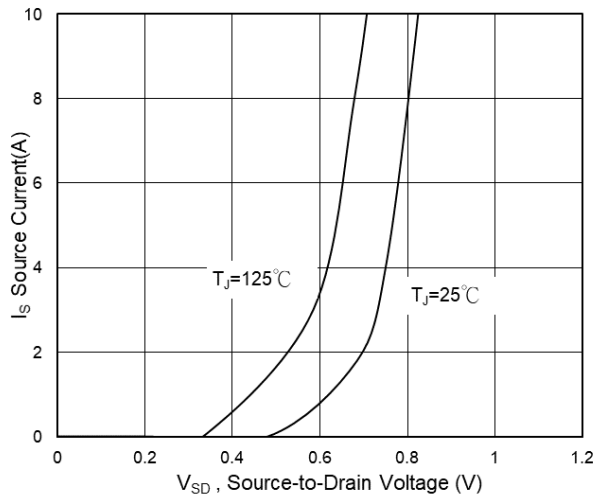

Source Drain Forward Characteristics

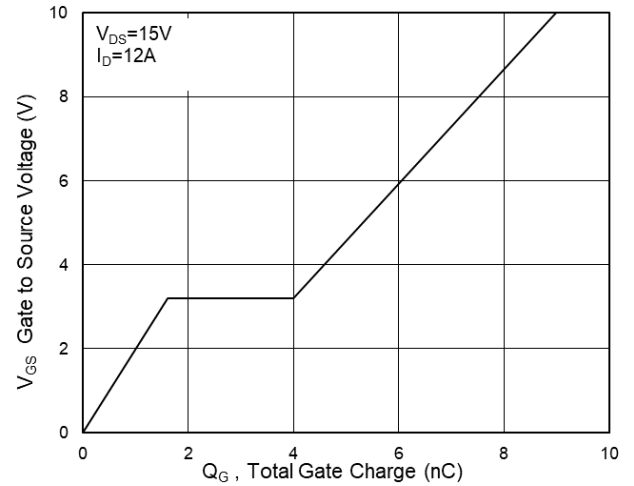

Gate-Charge Characteristics

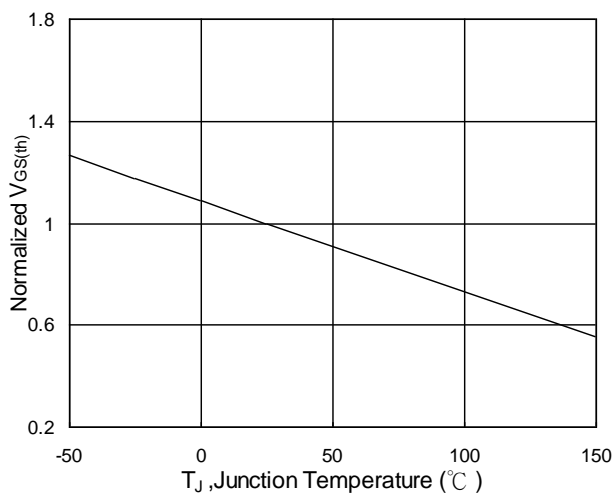

Normalized $V_{GS(th)}$ vs T_J

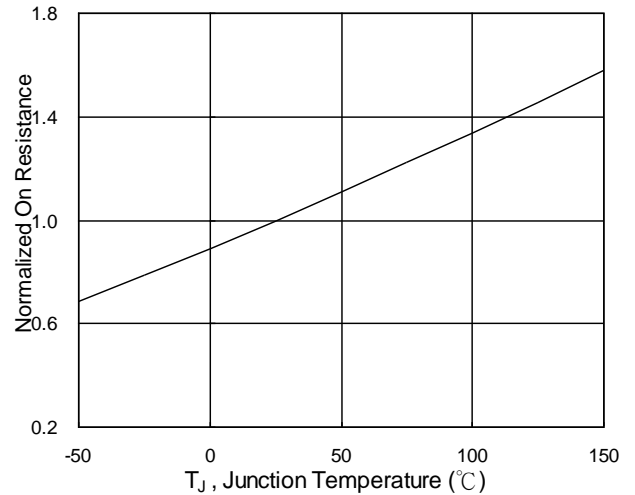

Normalized $R_{DS(on)}$ vs T_J

TYPICAL CHARACTERISTICS (25°C , unless otherwise noted)

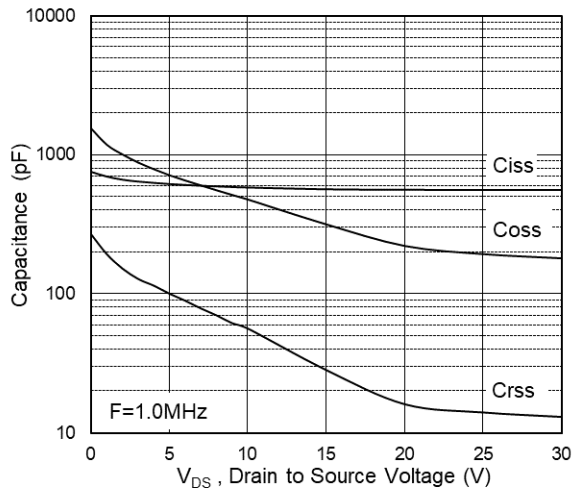

Capacitance

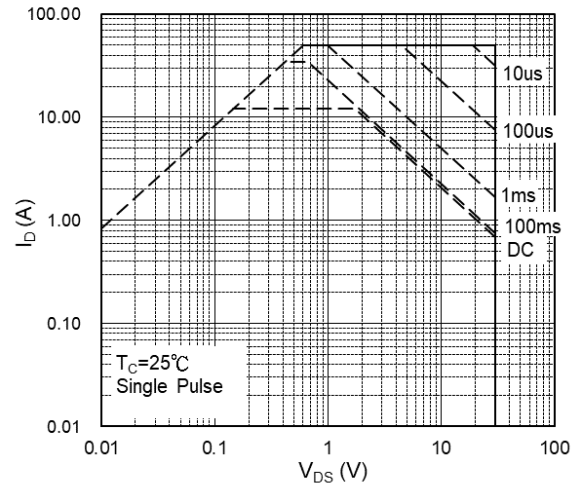

Safe Operating Area

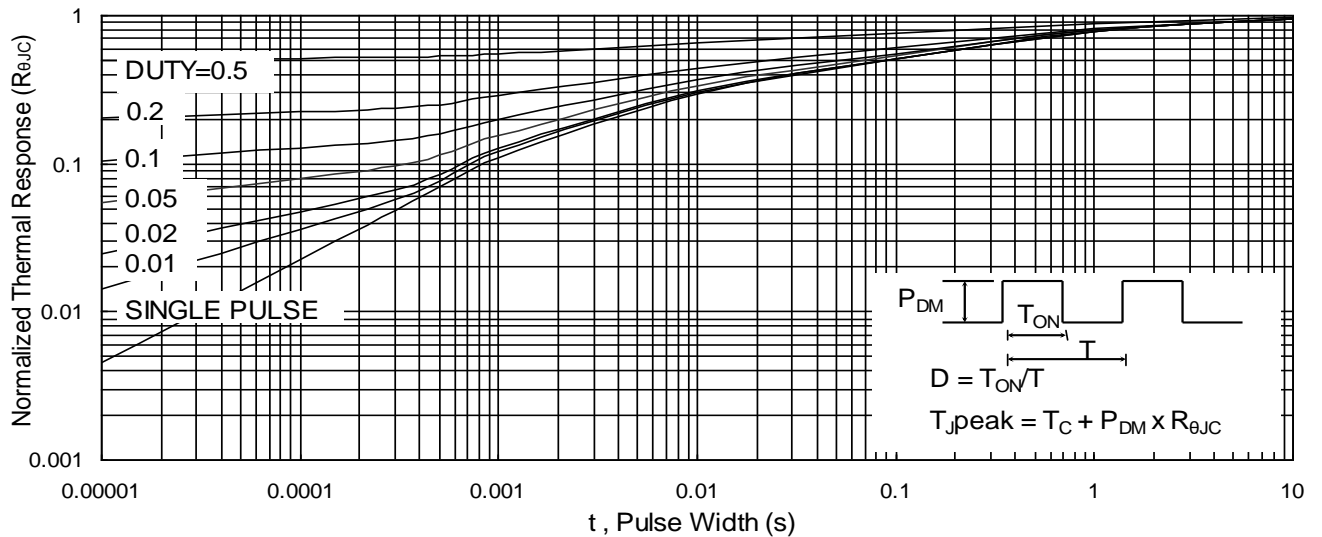

Normalized Maximum Transient Thermal Impedance

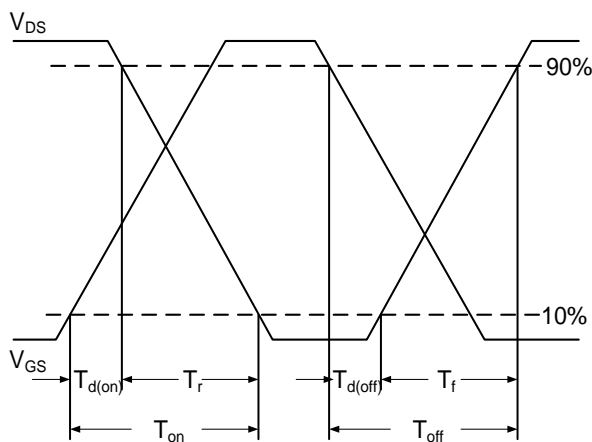

Switching Time Waveform

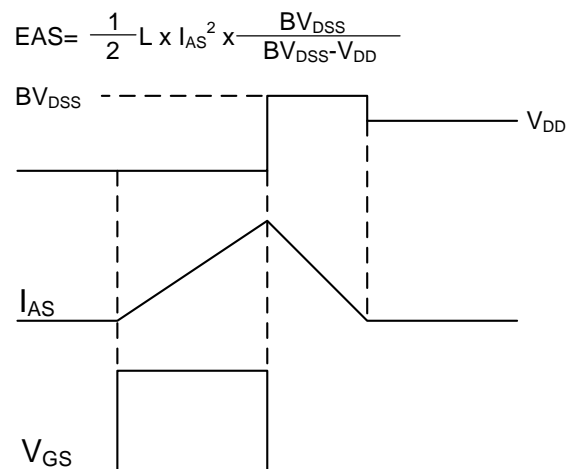

Unclamped Inductive Switching Waveform

$$EAS = \frac{1}{2} L \times I_{AS}^2 \times \frac{BV_{DSS}}{BV_{DSS} - V_{DD}}$$

PDFN 3.3X3.3 PACKAGE OUTLINE

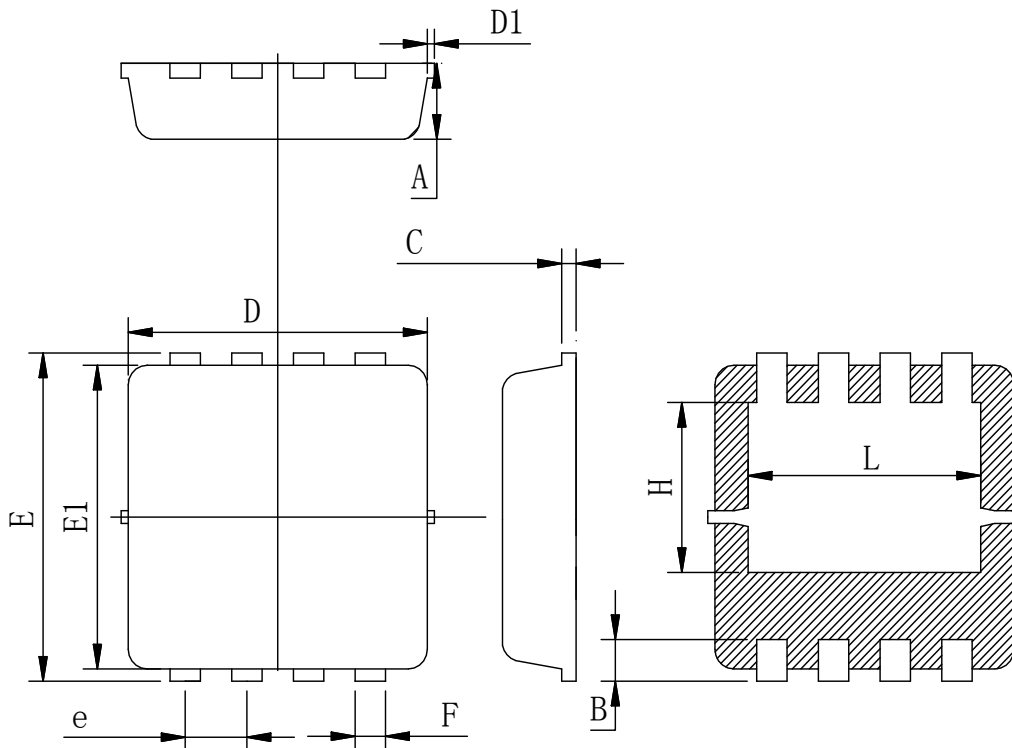

COMMON DIMENSIONS
(UNITS OF MEASURE=MILLIMETER)

| Symbol | Min | Typ | Max |
|--------|-------|-------|-------|
| A | 0.600 | 0.775 | 1.000 |
| B | 0.20 | 0.38 | 0.55 |
| C | 0.05 | 0.15 | 0.40 |
| D | 3.10 | 3.25 | 3.50 |
| D1 | - | - | 0.15 |
| E | 3.15 | 3.35 | 3.50 |
| E1 | 2.60 | 3.10 | 3.45 |
| e | 0.50 | 0.65 | 0.80 |
| F | 0.15 | 0.32 | 0.45 |
| H | 1.25 | 1.73 | 2.10 |
| L | 2.20 | 2.45 | 2.85 |

Disclaimer

ALL PRODUCT, PRODUCT SPECIFICATIONS AND DATA ARE SUBJECT TO CHANGE WITHOUT NOTICE TO IMPROVE RELIABILITY, FUNCTION OR DESIGN OR OTHERWISE.

Din-Tek Intertechnology, Inc., its affiliates, agents, and employees, and all persons acting on its or their behalf (collectively, "Din-Tek"), disclaim any and all liability for any errors, inaccuracies or incompleteness contained in any datasheet or in any other disclosure relating to any product.

Din-Tek makes no warranty, representation or guarantee regarding the suitability of the products for any particular purpose or the continuing production of any product. To the maximum extent permitted by applicable law, Din-Tek disclaims (i) any and all liability arising out of the application or use of any product, (ii) any and all liability, including without limitation special, consequential or incidental damages, and (iii) any and all implied warranties, including warranties of fitness for particular purpose, non-infringement and merchantability.

Statements regarding the suitability of products for certain types of applications are based on Din-Tek's knowledge of typical requirements that are often placed on Din-Tek products in generic applications. Such statements are not binding statements about the suitability of products for a particular application. It is the customer's responsibility to validate that a particular product with the properties described in the product specification is suitable for use in a particular application. Parameters provided in datasheets and/or specifications may vary in different applications and performance may vary over time. All operating parameters, including typical parameters, must be validated for each customer application by the customer's technical experts. Product specifications do not expand or otherwise modify Din-Tek's terms and conditions of purchase, including but not limited to the warranty expressed therein.

Except as expressly indicated in writing, Din-Tek products are not designed for use in medical, life-saving, or life-sustaining applications or for any other application in which the failure of the Din-Tek product could result in personal injury or death. Customers using or selling Din-Tek products not expressly indicated for use in such applications do so at their own risk. Please contact authorized Din-Tek personnel to obtain written terms and conditions regarding products designed for such applications.

No license, express or implied, by estoppel or otherwise, to any intellectual property rights is granted by this document or by any conduct of Din-Tek. Product names and markings noted herein may be trademarks of their respective owners.

Material Category Policy

Din-Tek Intertechnology, Inc. hereby certifies that all its products that are identified as RoHS-Compliant fulfill the definitions and restrictions defined under Directive 2011/65/EU of The European Parliament and of the Council of June 8, 2011 on the restriction of the use of certain hazardous substances in electrical and electronic equipment (EEE) - recast, unless otherwise specified as non-compliant.

Please note that some Din-Tek documentation may still make reference to RoHS Directive 2002/95/EC. We confirm that all the products identified as being compliant to Directive 2002/95/EC conform to Directive 2011/65/EU.

Din-Tek Intertechnology, Inc. hereby certifies that all its products that are identified as Halogen-Free follow Halogen-Free requirements as per JEDEC JS709A standards. Please note that some Din-Tek documentation may still make reference to the IEC 61249-2-21 definition. We confirm that all the products identified as being compliant to IEC 61249-2-21 conform to JEDEC JS709A standards.